

AECOM

locality
the power of community

Blandford+

Design Guidance and Codes

FINAL REPORT
MARCH 2023

Delivering a better world

Quality information

Prepared by	Check by	Approved by
Hoorieh Morshedi	Niltay Satchell	Ben Castell
Urban Designer	Associate Urban Designer	Director
Daniel Mather		
Graduate Urban Designer		
Chatnam Lee		
Graduate Urban Designer		

Revision History

Issue no.	Issue date	Details	Issued by	Position
3	22/02/2023	Review	Niltay Satchell	Associate Urban Designer
	22/02/2023	Address comments	Hoorieh Morshedi	Urban Designer
2	20/02/2023	Review	Linda Scott-Giles	Blandford Forum Town Clerk
	30/11/2022	Review	Niltay Satchell	Associate Urban Designer
	30/11/2022	Address comments	Hoorieh Morshedi	Urban Designer
	30/11/2022	Address comments	Rose Bateman	Senior Planner
1	08/11/2022	Review	Linda Scott-Giles	Blandford Forum Town Clerk
	19/10/2022	Review, site visit	Niltay Satchell	Associate Urban Designer
	19/10/2022	Research, site visit, drawings	Hoorieh Morshedi	Urban Designer
	11/10/2022	Research, drawings	Daniel Mather	Graduate Urban Designer
	11/10/2022	Research, drawings	Chatnam Lee	Graduate Urban Designer

This document has been prepared by AECOM Limited ("AECOM") in accordance with its contract with Locality (the "Client") and in accordance with generally accepted consultancy principles, the budget for fees and the terms of reference agreed between AECOM and the Client. Any information provided by third parties and referred to herein has not been checked or verified by AECOM, unless otherwise expressly stated in the document. AECOM shall have no liability to any third party that makes use of or relies upon this document.

Contents

01 —	1. Introduction	5	04 —	4. Design Guidance and Codes	45
	1.1 Purpose of this document	5		4.1 Introduction	45
	1.2 Area of study	6		4.2 How to apply design codes to character areas	102
	1.3 Design guidance and best practice	9		4.3 Checklists	113
02 —	2. Neighbourhood Area Context Analysis	14	05 —	5. Delivery	122
	2.1 Town structure and movement	14		5.1 How to use this guide	122
	2.2 Historic and landscape features	18			
	2.3 Topography and flood risk	21			
03 —	3. Character Area Assessment	24			
	3.1 Defining the Character Areas	24			



Introduction

01

1. Introduction

Through the Department for Levelling Up, Housing and Communities Neighbourhood Planning Programme led by Locality, AECOM was commissioned to provide design support to Blandford Forum Town Council, Blandford St Mary Parish Council and Bryanston Parish Council. The support is intended to provide design guidance and codes based on the character and local qualities of the area to help influence residential developments.

1.1 Purpose of this document

The Neighbourhood Plan Steering Group has sought to develop design guidelines and codes for future development in the Neighbourhood Area.

The National Planning Policy Framework (NPPF; 2021, paragraph 127) states that “Neighbourhood planning groups can play an important role in identifying the special qualities of each area and explaining how this should be reflected in development, both through their own plans and by engaging in the production of design policy, guidance and codes by local planning authorities and developers.”

The stages of production for this document are outlined here:

STEP 1

Meeting with the group and site visit.

STEP 2

Urban design and local character analysis.

STEP 3

Preparation of the design principles, guidelines and codes.

STEP 4

Draft report with design guidelines and codes.

STEP 5

Submission of a final report.

1.2 Area of study

The Blandford+ Neighbourhood Area consists of three parishes, Blandford Forum, Blandford St Mary and Bryanston. The parishes are located in the county of Dorset in the south of England (see **Figure 022**).

The main settlement of the Blandford+ Neighbourhood Area is Blandford Forum. Other nearby large settlements include Poole and Bournemouth to the south and Salisbury to the north-east. The South Western Railway on the south coast connects the Neighbourhood Area with London (see **Figure 03**).



F.1

Figure 01: Stour Meadow in Blandford Forum

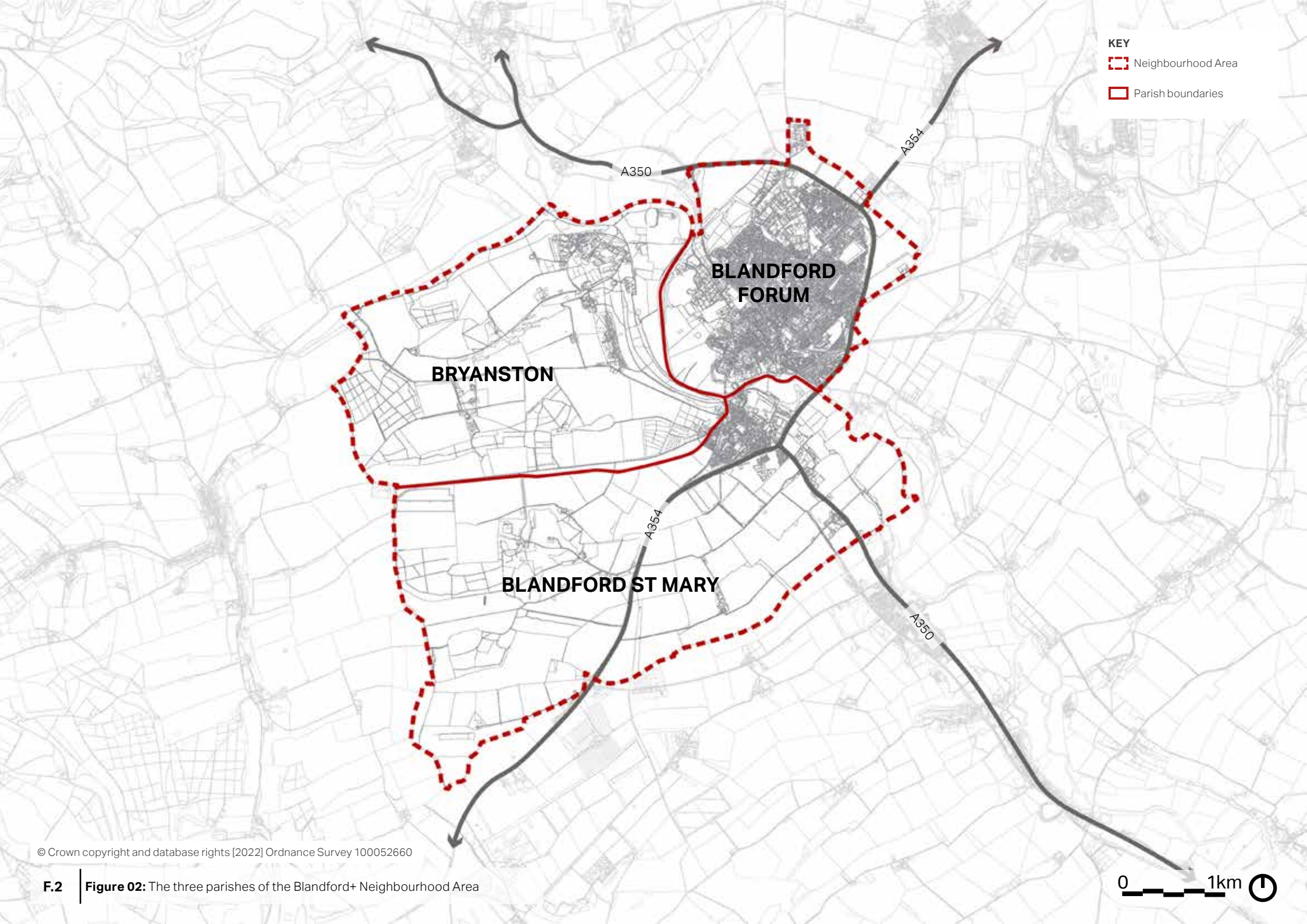

KEY
- - - Neighbourhood Area
—— Parish boundaries

© Crown copyright and database rights [2022] Ordnance Survey 100052660

F.2 | **Figure 02:** The three parishes of the Blandford+ Neighbourhood Area

0 1km

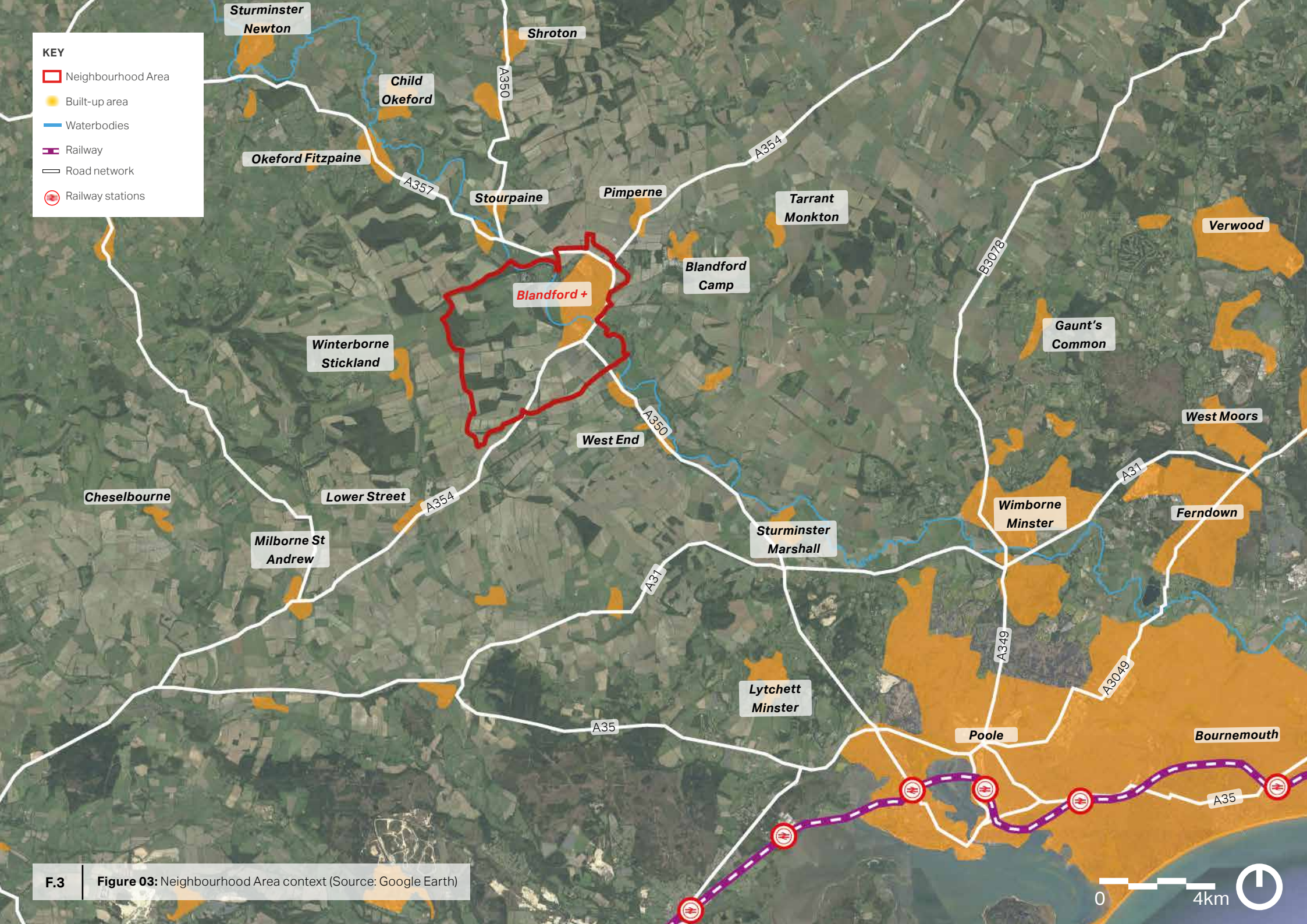

F.3 | **Figure 03:** Neighbourhood Area context (Source: Google Earth)

1.3 Design guidance and best practice

This section summarises the relevant design policy, guidance and evidence base which have informed this design code. Any new development application should consider these documents.

National Design Guidance

2021



National Planning Policy Framework - Department for Levelling Up, Housing and Communities

Relevant national planning policy is contained within the National Planning Policy Framework (NPPF, July 2021). The NPPF was updated in July 2021 to include reference to the National Design Guide and National Model Design Code and the use of area, neighbourhood and site-specific design guides. Paragraph 126 states that: “the creation of high quality buildings and places is fundamental to what the planning and development process should achieve” and outlines that “good design is a key aspect of sustainable development, creates better places in which to live and work and helps make development acceptable to communities.”

2021



National Design Guide - Department for Levelling Up, Housing and Communities

The National Design Guide sets out the government’s ten priorities for well designed places and illustrates how well-designed places can be achieved in practice. The ten characteristics identified include: context, identity, built form, movement, nature, public spaces, uses, homes and buildings, resources and lifespan. The Guide also reinforces the National Planning Policy Framework’s objective in creating high quality buildings and places. The document forms part of the government planning practice guidance.

2021



National Model Design Code - Department for Levelling Up, Housing and Communities

The draft National Model Design Code provides guidance on the production of design codes, guides and policies to promote well-designed places. It sets out the key design parameters that need to be considered when producing design guides and recommends methodology for capturing and reflecting views of the local community.

2020



Building for a Healthy Life - Homes England

Building for a Healthy Life updates Homes England's key measure of design quality as the national housing accelerating body. The document sets out 12 considerations for creating integrated neighbourhoods, distinctive places and streets for all. While it is not part of the national policy, it is recognised as best practice guidance and design tool in assessing the design quality of developments.

2007



Manual for Streets - Department for Transport

Development is expected to respond positively to the Manual for Streets, the Government's guidance on how to design, construct, adopt and maintain new and existing residential streets. It promotes streets and wider development that avoid car dominated layouts and promote active travel.

2016



North Dorset Local Plan – Dorset Council

The North Dorset Local Plan is part of the Local Development Plan. Adopted in January 2016, the Local Plan sets out the spatial vision and strategy for the district over the period of 2011 to 2031. The Local Plan also includes topic and place-based strategic policies to guide new development and strategic development management policies that provide further detail on key matters.

A new Local Plan is currently being prepared by the newly formed Dorset Council unitary authority for the whole Dorset Council Area. The new Local Plan will replace plans adopted by the district and borough council areas of Dorset.

2021



Blandford+ Neighbourhood Plan – Blandford+

The first Blandford + Neighbourhood Plan is part of the Local Development Plan. Adopted in June 2021, the Local Plan sets out the community’s vision with planning policies for the Neighbourhood Area over the period 2011 to 2033. The planning policies for design seek to sustain and enhance the Neighbourhood Area.

This design code builds upon the Blandford+ Neighbourhood Plan vision, objectives and planning policies for design. It also considers the design reports prepared as evidence for the Neighbourhood Plan, namely Design in Blandford Forum 2015 (updated 2018), Design in Blandford St Mary 2015 (updated 2018), and Design in Bryanston 2015 (updated 2018).

2014

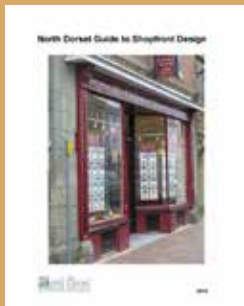

North Dorset Guide to Shopfront Design – Dorset Council

The North Dorset Guide to Shopfront Design provides information on shopfront signage and architectural features to guide alterations, replacements and restorations. It was produced in partnership with Blandford Forum Town Council.

This design guide notes the North Dorset Guide to Shopfront Design as being relevant in the Neighbourhood Area and provides additional high-level guidance on shopfronts.

2011

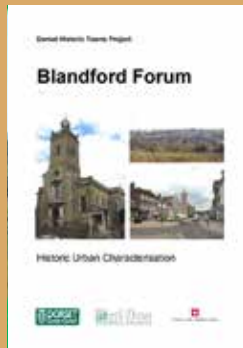

Dorset Historic Towns Project – Dorset County Council

The Dorset Historic Towns Survey analyses the historic character of towns in Dorset. The report highlights aspects of each towns' historical development and how this has shaped the urban environment today. Blandford Forum is recognised for being closely bound with its distinctive landscape setting, its historic fabric quality, and its preserved medieval layout. Character Appraisals have been completed for the medieval town, Salisbury Street, Milldown Road, Railway suburb, North and East Blandford and Blandford St Mary.

2019



Areas of Outstanding Natural Beauty (Management Plans – National Association for Areas of Outstanding Natural Beauty (AONB)

The Cranborne Chase Partnerships Plan 2019-2024 and Dorset Management Plan 2019-2024 are the statutory management plans for the AONB within the Neighbourhood Area. The management plans detail the unique attributes and key considerations for each AONB. The Dorset AONB Management Plan is supported by several documents that provide further guidance on planning and development within the AONB, including for rural highways.

2018



Conservation Area Appraisal – Dorset Councils Partnership

Blandford Forum is best known as one of the finest examples of a Georgian Town in Britain. The Conservation Area was designated in 1972 - as proposed and detailed in the Blandford Forum Conserve and Enhance 1970 report - and significantly expanded in 1990. It consists of nine sub-areas that represent a coherent pattern of development and character. The appraisal is focused on the historic town centre including the area to the south of the town bridge within Blandford St. Mary together with 19th century suburbs to the north. The remaining sub-areas will be subject to a further study.

A street scene in a historic town, likely in the UK. The street is paved with cobblestones and has a double yellow line. On the left, there is a stone wall and a grassy area. On the right, there are brick buildings with white window frames. One building has a sign that says "BAKER SHO" and another has a sign that says "GEORGIAN PASSAGE". The sky is blue with some clouds.

**Neighbourhood Area
Context Analysis**

02

2. Neighbourhood Area Context Analysis

This section outlines the broad physical, historic and contextual characteristics of the Neighbourhood Area.

2.1 Town structure and movement

2.1.1 Pattern of development

Historic maps suggest that Blandford Forum settlement originated where the Conservation Area was first designated. In 1731, a devastating fire burned down almost all of the market town. The post-fire rebuild of the Blandford Forum involved little planning, although the street layout was improved and the Market Place and Church precincts were created. Many buildings rebuilt after the fire remain today and contribute significantly to the local historic character.

Since the rebuild, the market town has grown significantly. Several residential areas and some industrial estates have developed primarily to the north/north-east and south/south-east.

Bryanston School is also a key focal point of the Neighbourhood Area, which is located to the west of Blandford Forum.

2.1.2 Plot and road layout

The primary roads that connect to the Neighbourhood Area include the A350, the A354 and Salisbury Road. These roads provide access to Salisbury, Dorchester, Poole and Bournemouth.

Fair Mile Road splits the parishes of Blandford St Mary and Bryanston. The centre of Blandford St Mary is transversed by the A354, which provides fast accessibility to the town, however, it also acts as a barrier which splits the north and south of the Neighbourhood Area. On the other hand, Bryanston is connected by rural roads.

In terms of Blandford Forum, the central node is the Market Place, which secondary roads sprawl out from. Salisbury Road is a key route into the town centre from which most residential areas branch off; there are over twenty junctions along the road between the town centre and the edge of the settlement.

A permeable block typology is the prevalent layout of residential areas, which provides good connectivity. There are some examples of cul-de-sacs that enhance the tranquility of streets but limit connectivity. Residential roads are narrow and typically have pavement on either side of the street. Grass verges are common throughout the residential areas and help create a green and leafy character. There is a mix of on-plot and on-street car parking. Although, the on-street parking has resulted in safety issues in some areas.

2.1.3 Public and active transport

There are several bus routes in the town centre and residential areas, providing connections to places such as Poole, Weymouth and other parts of the Neighbourhood Area. This encourages people to use public transport, resulting in fewer cars in the town centre.

In terms of active transport, the roads are not cycle friendly as they are narrow with no cycle lanes. There is pavement on either

side of the road throughout Blandford, although in central areas it is sometimes narrow which can be challenging for some users, such as people with buggies. Some cycle parking is provided in the town centre but there is an opportunity to provide additional safe spaces.

Outside of the town there is a network of public footpaths which make the most of the natural beauty of the Neighbourhood Area. The footpaths cut through the woodland and the open fields of the Dorset AONB, encouraging people to get outside and go on walks and bike rides. This asset encourages an active lifestyle for improved physical and mental health.



Figure 04: Part of the Stour Meadows



Figure 05: Mix of uses along Market place in Blandford Forum

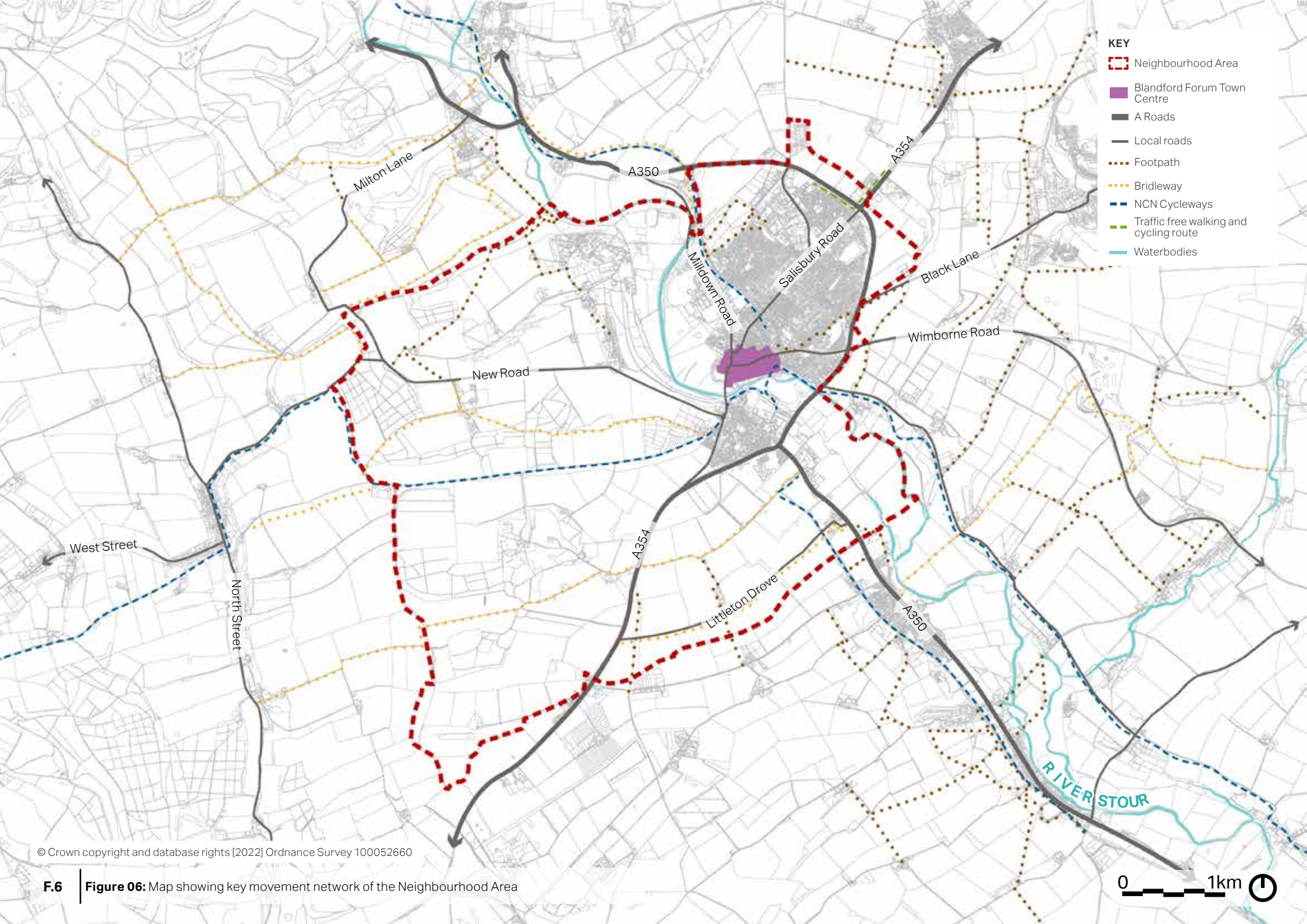

- KEY**
- Neighbourhood Area
 - Blandford Forum Town Centre
 - A Roads
 - Local roads
 - Footpath
 - Bridleway
 - NCN Cycleways
 - Traffic free walking and cycling route
 - Waterbodies

© Crown copyright and database rights [2022] Ordnance Survey 100052660

F.6 | **Figure 06:** Map showing key movement network of the Neighbourhood Area





F.7



F.9



F.8



F.10

Figure 07: A rural road without pavements in Bryanston. The road is bounded by green verges and mature trees and provides direct the view towards the countryside

Figure 08: Wimborne Road is one of the main roads towards the town centre. The buildings are well set back from the pavement with adequate front gardens

Figure 09: Footpaths help to increase connectivity within the Neighbourhood Area

Figure 10: Footpath on East Street adjacent to St Peter and St Paul's Church

2.2 Historic and landscape features

2.2.1 Historic features

The name Blandford derives from the Old English blæge, and probably means ford where gudgeon or blay are found. It is taken to mean 'place by the river' or after a fish called a 'blenny'. The name Bleneford or Bleneford is recorded in the Domesday Book in reference to the adjacent villages of Bryanston and Blandford St Mary on the opposite side of the ford, and Langton Long Blandford further downstream.

Blandford Forum is best known as one of Britain's finest Georgian Towns. A Conservation Area was designated in 1972 to preserve and enhance its historic character. This area was significantly expanded in 1990 to include areas in Blandford, Blandford St. Mary and Bryanston (see **Figure 11**). Given this rich history, Blandford also is the home to dozens of listed buildings and two scheduled monuments, which are detailed on the [Historic England website](https://historicengland.org.uk/)¹.

1. <https://historicengland.org.uk/>

2.2.2 Environment and green infrastructure

Most the countryside surrounding the settlements in the Neighbourhood Area is long-established arable farmland. The Neighbourhood Area is valued for its natural beauty with several significant features including veteran trees.

Over half of the Neighbourhood Area to the west lies within the chalk valley and downland and the stour valley pasture character areas of the Dorset AONB. Part of the Neighbourhood Area to the north and east is within the Cranborne Chase and West Wiltshire Downs AONB. The settlement of Blandford Forum is nestled between the two AONB, which makes it a picturesque place to live and visit, and makes a significant contribution to its character.

The Neighbourhood Area provides a range of habitats for wildlife to thrive. Chalk and limestone grassland sites have areas of grassland, which supports many low-flowering plants, alongside areas of bare ground, longer vegetation and scrub,

which provides habitat for insects, birds, amphibians and reptiles.

There is a small Site of Special Scientific Interest (SSSI) - Bryanston SSSI - just south of Bryanston School. It is known as the habitat of Greater Horseshoe Bat, managed by the Vincent Wildlife Trust. The population is of national importance and therefore afforded high levels of protection, placing significant legal duties on decision-makers to prevent damage to bat roosts, feeding areas and the routes used by bats to travel between these locations. There are also various Ancient Woodlands within the Neighbourhood Area, the largest of which is located in the west. A woodland area in Bryanston is also a Site of Nature Conservation Interest (SNCI) known as The Cliff.

Splitting the Neighbourhood Area into two is the River Stour, which travels south towards Poole and the English Channel. It is a great asset to the area not just for aesthetically pleasing walks but also for biodiversity.

- KEY**
- Neighbourhood Area
 - Conservation Area 1972
 - Conservation Area 1990
 - AONB
 - SSSI
 - Ancient Woodland
 - Other woodlands
 - Meadow
 - Sport facilities
 - Cemetery
 - Sport space
 - Public park or garden
 - Milldown LNR
 - Allotment
 - Playing field
 - ▲ Veteran trees
 - Scheduled monuments
 - Waterbodies
 - Road network

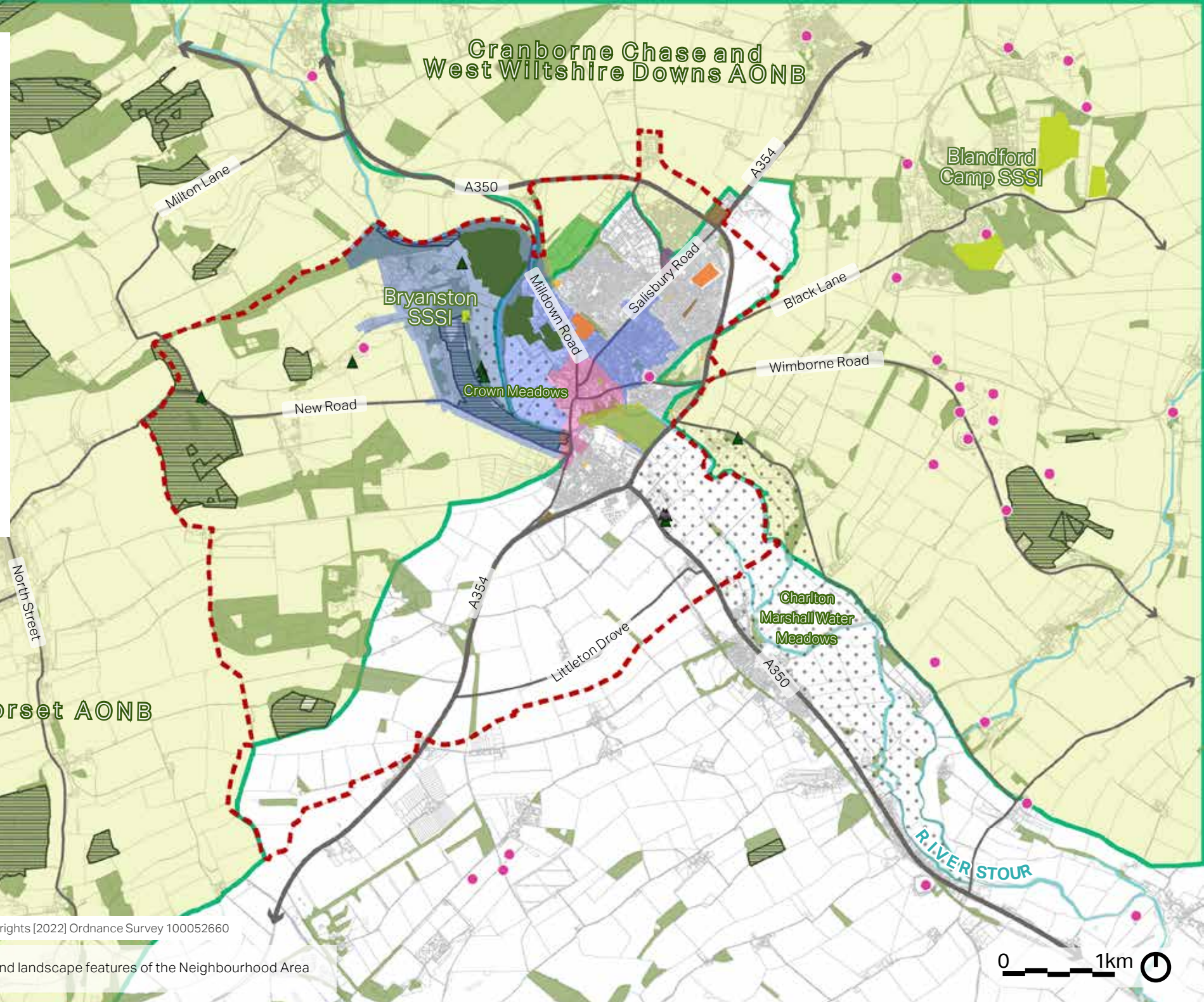

© Crown copyright and database rights [2022] Ordnance Survey 100052660

F.11 Figure 11: Historic and landscape features of the Neighbourhood Area

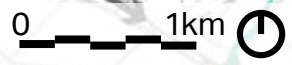



Figure 12: A view towards the sport facilities of Bryanston School



Figure 13: The landscape in Bryanston School grounds with mature trees and large green verges which add interest to this character area



Figure 14: A view towards Pimperne Stream on Blandford Forum Bypass



Figure 15: A play area in Bryanston



Figure 16: A view towards the woodland in Stour Meadows

F.12

F.13

F.14

F.15

F.16

2.3 Topography and flood risk

The Neighbourhood Area is characterised by rolling hills with elevations ranging from about 30 to 145 metres above sea level. The land generally slopes down from the north to the south of the Neighbourhood Area as well as sloping down from both the east and west. This means that the settlements of the Neighbourhood Area are within a valley and have panoramic countryside views of the surrounding hillside.

Running directly through the valley is the River Stour which comes from Stourhead in Wiltshire. It flows south into Dorset through the Blackmore Vale and joins the English Channel. While this adds to the character and natural beauty of the area, it also creates a flood risk. High rainfall and heavy surface run off from the hillside into the river can lead to it bursting its banks and flooding surrounding areas.

An area within Flood Risk Zone 3 runs through the Neighbourhood Area along the River Stour, cutting through the main settlement and putting properties at risk.

Development within Flood Risk Zone 3 is required to submit a flood risk assessment as part of its planning application¹.

The Stour Meadows Park works as a mitigator for flood risk by acting as a flood plain. Although, some properties in the town are still at an increasing risk of being flooded as climate change continues to have an impact on meteorological conditions.

1. <https://www.ambiental.co.uk/flood-zones/>



F.17

Figure 17: Photo showing the elevation difference in Bryanston School



F.18

Figure 18: River Stour as a flood plain acting as a mitigator for flood risk

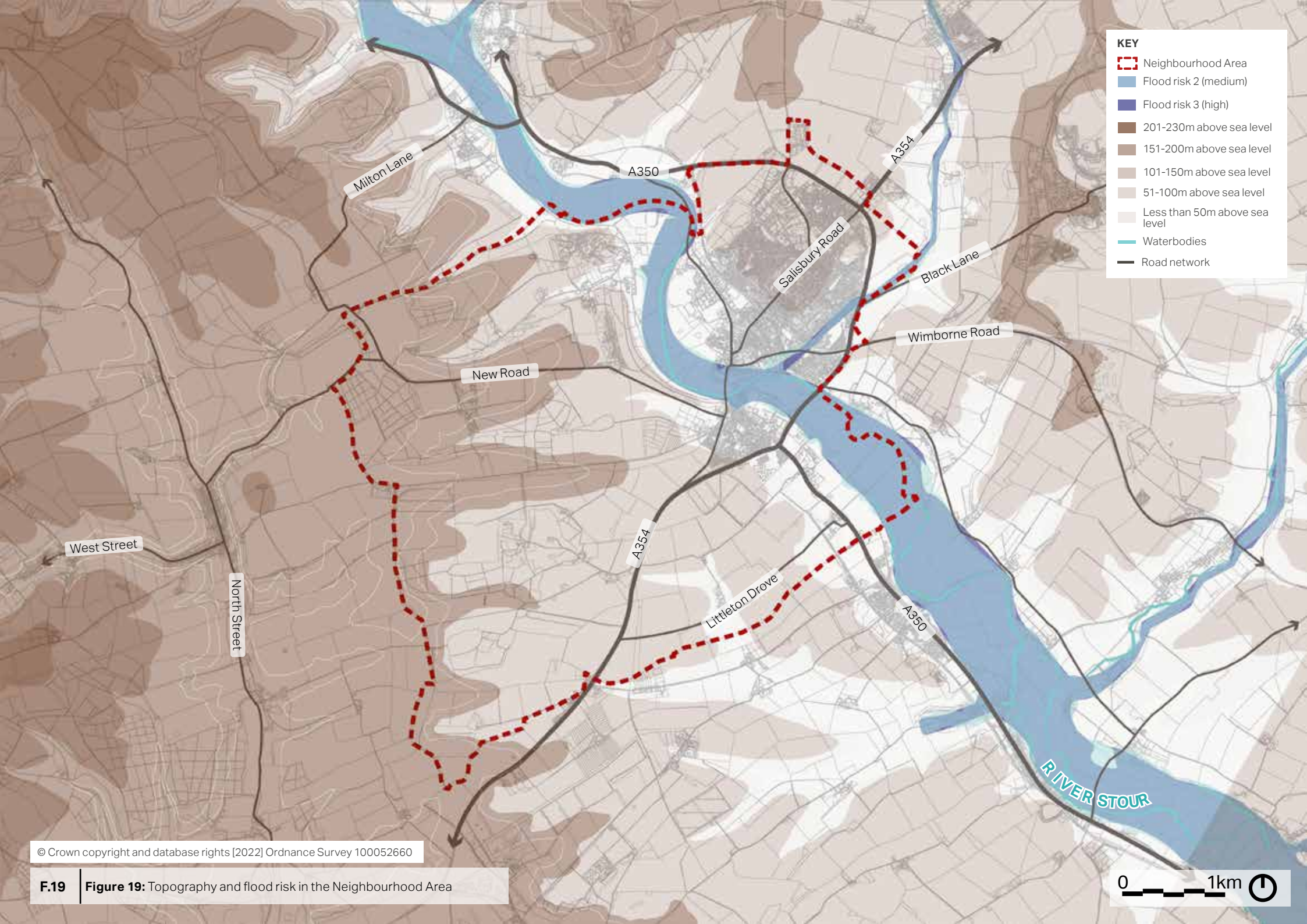



KEY

- Neighbourhood Area
- Flood risk 2 (medium)
- Flood risk 3 (high)
- 201-230m above sea level
- 151-200m above sea level
- 101-150m above sea level
- 51-100m above sea level
- Less than 50m above sea level
- Waterbodies
- Road network

© Crown copyright and database rights [2022] Ordnance Survey 100052660

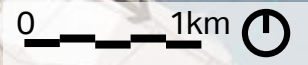
F.19 | **Figure 19:** Topography and flood risk in the Neighbourhood Area





**Character Area
Assessment**

03

3. Character Area Assessment

3.1 Defining the Character Areas

Following on from the analysis set out above, this part of the report focuses on the different Character Areas within the Neighbourhood Area. The different areas are characterised by variations in topography, movement, views and landmarks, green space and landscape cover, public realm, streetscape, built form and architectural details.

The Neighbourhood Area has nine Character Areas (see **Figure 20**), which have been defined in collaboration with the group, and are shown opposite.

CA1. Blandford Forum and Approaches

CA2. Blandford Town

CA3. Bryanston

CA4. Blandford Residential

CA5. Industrial

CA6. Edge of the Town

CA7. Blandford St Mary Residential

CA8. Bryanston Rural Area

CA9. Countryside of Blandford St Mary

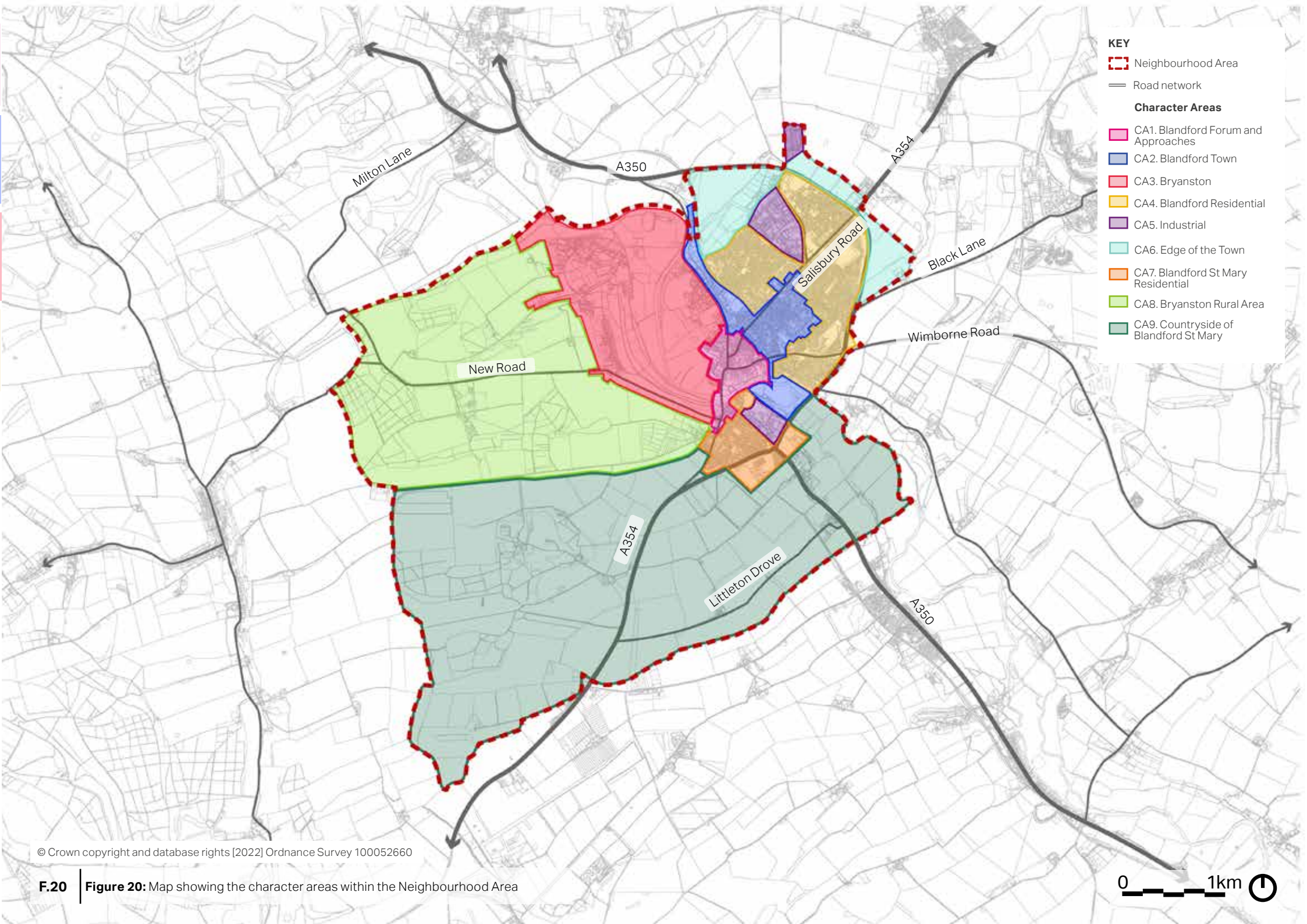

F.20 | **Figure 20:** Map showing the character areas within the Neighbourhood Area

CA1. Blandford Forum and Approaches



The Blandford Forum and Approaches is located in the town centre. It consists of the original Conservation Area first designated in 1972 to preserve and enhance Blandford's historic character.

Land Use	The Character Area covers the town centre and contains a mix of uses. The southern part along Market Place is dominated by retail units, which transitions to residential further north along Salisbury Street. However, there is a transition toward residential uses to the east of East Street.
Pattern Of Development	Development has grown along two main roads in the Character Area: Market Place and Salisbury Street. Cul-de-sacs branching off of these roads are also typical for this area.
Building Line/Plot Arrangement	There is an established continuous building line in the Character Area, particularly in retail areas such as the Market Place. The building line creates a linear feel to the environment but also encourages natural surveillance. Landmark buildings create rare gaps in the building line, such as the St Peter and St Paul's Church.
Boundary Treatment	Plots are defined by the buildings, which front directly onto the street.
Heights & Roofline	There is a varied roofline in the Character Area, with building heights ranging from two to four storeys.
Public Realm	The public realm primarily consists of narrow streets with limited vegetation. The streets are wider with on-street parking in East Street and Market Place. However, there are Milldown Road and St Leonard's Avenue which are tree-lined with larger plots/larger gardens.
Materials	Historic buildings are mostly red brick with stone dressings and headers. Façades include brickwork detailing in contrasting colours which connect the openings of one storey with those of another. Roofs are either clay tile or slate, a later 19th century import.

Images



Figure 21: View toward the Georgian buildings at the intersection of Market Place and Salisbury Street

Figure 22: Two-storey Georgian buildings with car parking areas on The Plocks

Figure 23: Pump House, a Grade I listed, acts as a landmark just in front of St Peter and St Paul's Churchyard on Market Place

Figure 24: Corn Exchange as a landmark on Market Place

Figure 25: The Ground floor retail units along Market Place opposite the church



CA2. Blandford Town

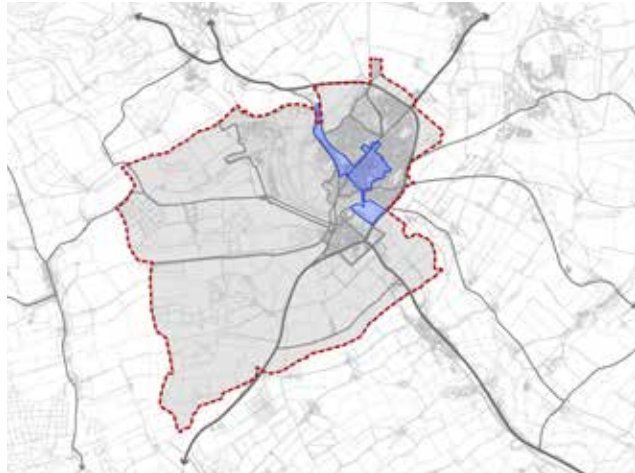

Blandford Town is located in the north of the Neighbourhood Area. It is part of the wider Conservation Area designated in 1990. It is home to two of the Neighbourhood Area's main schools as well as traditional terraced and semi-detached housing.

Land Use	The Character Area is primarily residential, with the exception of a community hospital, Blandford School, Milldown Academy and Panda Pre-School.
Pattern Of Development	The residential area was the early expansion from the town centre to the south. It consists of a square block typology which enhances accessibility and permeability for both pedestrians and motorists.
Building Line/Plot Arrangement	Plots are typically arranged back-to-back, which optimises privacy and natural surveillance of the streets. Buildings are typically of a terraced typology, with some semi-detached. The terraced housing lends itself to a consistent building line, which is setback one to two metres from the street.
Boundary Treatment	Plots are typically defined by a low red brick wall and vegetation, such as hedges. Some building front directly onto the street.
Heights & Roofline	Buildings are typically two storeys in height, which maintains the human scale of the narrow street. Most terrace housing in the Character Area has hipped roofs.
Public Realm	The public realm has narrow streets and footpaths, and in some areas, no footpaths. However, the Character Area fronts fields and the River Stour, which offer large expanses of open space.
Material	Red brick and white render façades are most prevalent in the Character Area.

Images



F.26

Figure 26: Two and a half storey buildings with courtyard parking on Salisbury Road/Fairfield Road Junction



F.27

Figure 27: Rendered two-storey properties on Damory Court Street



F.28

Figure 28: A typical narrow street on Albert Street



F.29

Figure 29: Compact layout of plots on Alfred Street with narrow road layout

CA3. Bryanston



The Bryanston character area is located along the northern edge of the Neighbourhood Area and is part of the wider Conservation Area designated in 1990.

The land within Bryanston Character Area is part of the former extensive Portman Estate. This comprises Bryanston School in the former Portman mansion, the historic estate village of Bryanston, and the Crown Meadows and Deer Park on the opposite side of the River Stour. Extensive ancient woodland rises above the western edge of the river.

Land Use	Bryanston School and The Old Powerhouse are located to the north of the Character Area, and St Martin’s Church to the north-east. Residential areas are clustered around The Cliff, Bryanston Home Farm and New Road. Educational and residential development is located on the eastern edge of the character area within Blandford Town.
Pattern Of Development	Residential areas follow a linear pattern of development, with deep back gardens, especially along The Cliff. Houses are arranged in clusters at Bryanston Home Farm and Portman Mews.
Building Line/Plot Arrangement	Plots are typically large, backing onto surrounding woodlands and fronting the roads to provide natural surveillance. Houses are a mixture of detached, semi-detached and terraces, varying in age from early Victorian to post-war. Houses are aligned to create a consistent building line which is setback 10m from the street. Buildings as part of Bryanston School have larger footprints.
Boundary Treatment	Plots are defined by low brick and stone walls and vegetation, such as hedges and green verges. Iron railing and wooden fences are also used on some boundary edges. Residential areas also have deep front gardens.
Heights & Roofline	Buildings are typically two storeys in height, which maintains the human scale of the narrow streets. The Character Area contains a mix of hipped and pitched roof styles.
Public Realm	The public realm of residential areas has narrow streets and footpaths, which are only on one side of the road at times along The Cliff. The area also includes and open spaces along the River Stour, such as Crown Meadows and the Deer Park. The far eastern edge of the Character Area includes the mix of educational and residential development in Blandford Town.
Material	Red brick and white render facades are most prevalent in the Portman (western) section of the Character Area. Local stones are also sometimes utilised for boundary treatments.

Images



Figure 30: The Old Powerhouse, now a thriving Community Interest Company (CIC) in Bryanston, formerly the electricity generating station for Portman estate

Figure 31: A terrace of typical Portman estate houses, opposite the Model Farm, with large green verges that provide a feeling of openness

Figure 32: Multi pane casement window with red brick as decoration

Figure 33: Portman estate cottages, with typical red brick and blue banding, white sash windows and slate roofs (Source: Bryanston Non-Designated Heritage Assets List, V2)

Figure 34: A view toward Bryanston School and significant landscape



CA4. Blandford Residential

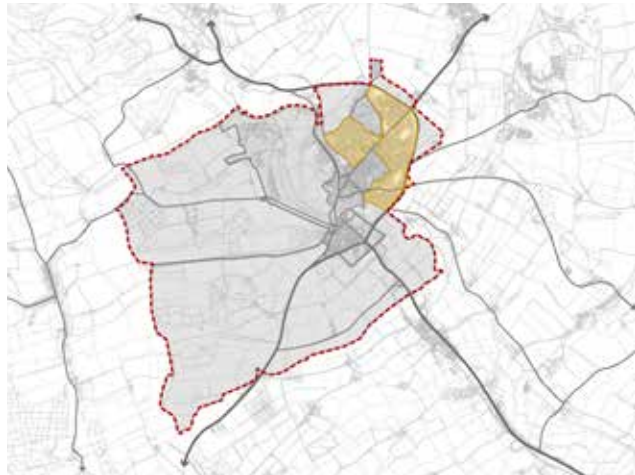

Blandford Residential is located to the north-east of the historic town centre. It is well separated from the River Stour and therefore not at risk from floods.

Land Use	The Character Area is primarily residential, with the exception of a convenience store and a Budgens garage.
Pattern Of Development	The Character Area consists of several housing estates that have been developed as the town has grown to the north-east. Higher density terraced housing is located closest to the town centre. Lower density detached housing is located further along Salisbury Road, further away from the town centre.
Building Line/Plot Arrangement	There is a range of residential typologies including detached, semi-detached, terraced and bungalows. Buildings are typically set back from the road with generous front gardens and on-plot parking, creating an open and leafy streetscape. The building line setback varies throughout the Character Area as a result of the estates being built over fifty years.
Boundary Treatment	Plots are most commonly defined by vegetation, but also in some instances, fences and low brick walls. This creates a leafy feel to the Character Area.
Heights & Roofline	The roofline in the Character Area is consistent, with building heights ranging from two to two and half storeys. The exception to this is an estate of bungalow houses to the east of the Character Area and areas of three storey detached houses on corner blocks.
Public Realm	The public realm consists of wide streets - typical five metres - with generous footpaths on either side. The Character Area also contains playing field, several pocket parks and an allotment.
Materials	Red brick, yellow brick and white render are the most prevalent building materials in the Character Area.

Images



Figure 35: Detached house with casement windows on Preetz Way

Figure 36: Detached house with a mix of flint and red brick on Salisbury Road

Figure 37: Terraced houses with dark brown pantiles on Elizabeth Road

Figure 38: The green space and mature trees on Fisher's Close softening the place

CA5. Industrial

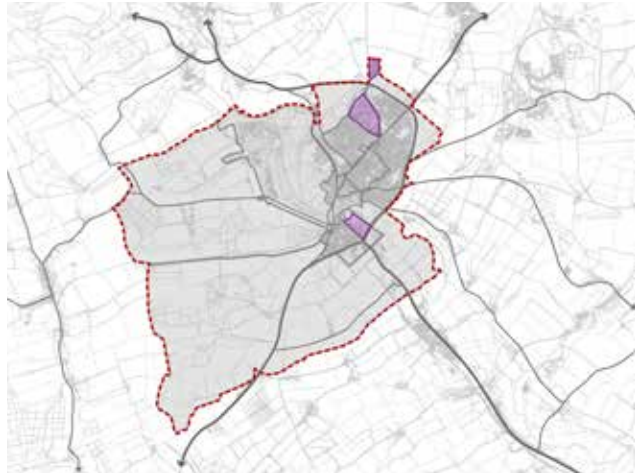

Industrial estates are located to the south of Blandford Forum within the Blandford St Mary parish, and at the northern outskirts of the town. They consist of a variety of different units in terms of use, shape and size, and are buffered from the surrounding residential areas with vegetation.

The Industrial Character Area to the south of Blandford Forum is part of the wider Conservation Area designated in 1990. It contains the original building of the Hall and Woodhouse Brewery.

Land Use	The Industrial estates of Character Area provide a wide range of retail and services, ranging from farming and gardening equipment, vehicle repair and sale, and interior design (services).
Pattern Of Development	Cul-de-sacs are typical within industrial estates as there are large parking courts for large delivery vehicles. Warehouse buildings are squared and front onto the parking courts.
Building Line/Plot Arrangement	The building line is not consistent as building sizes and parking courts vary throughout the industrial estates. Buildings footprints occupy most of the plots, with the remainder of space dedicated to vehicle movement and parking.
Boundary Treatment	Plots are most commonly defined by large metal fences, particularly for safety and security around outdoor storage areas.
Heights & Roofline	The roofline in the Character Area varies, with building heights of two storeys.
Public Realm	The public realm consists of wide streets with on-street parking and grass verges but limited footpaths.
Materials	Brick and corrugated iron are the most prevalent building materials in the Character Area.

Images



Figure 39: Residential development next to industrial site (Source: Blandford Plus NP Steering Group)



Figure 40: Warehouses as part of the Hall and Woodhouse Brewery, Blandford St Mary (Source: Blandford Plus NP Steering Group)

Figure 41: New brewery buildings, Blandford St Mary (Source: Blandford Plus NP Steering Group)

Figure 42: Original brewery building of the Hall and Woodhouse Brewery, Blandford St Mary (Source: Blandford Plus NP Steering Group)

Figure 43: Sunrise Industrial estate situated on northern edge of Blandford Forum (Source: Blandford Plus NP Steering Group)



CA6. Edge of the Town

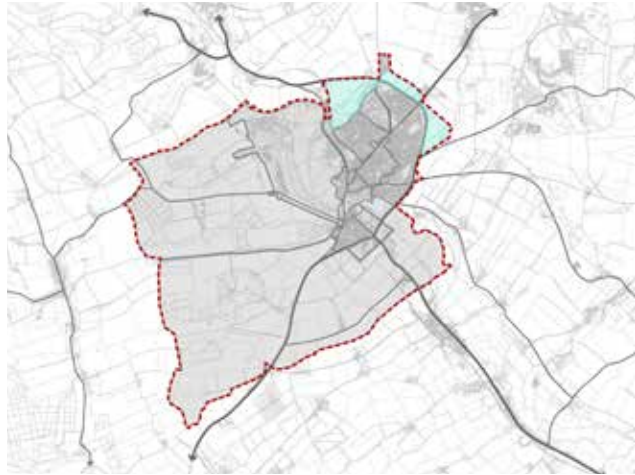

The edge of the town is located to the north-east of the Neighbourhood Area. It characterised by a green buffer in the form of fields between the settlement and the A350.

Land Use	The Character Area is primarily green space including arable farmland and the Milldown Nature Reserve. There are a small number of residential uses along Tin Pot Lane. A new school, allotment and residential development are proposed for this Character Area.
Pattern Of Development	Detached housing along Tin Pot Lane has been development on private cul-de-sac roads.
Building Line/Plot Arrangement	The orientation of the few buildings in the Character Area varies and therefore no consistent building line has been established. Large spacious plots provide gaps with views to the surrounding green space, which creates a rural character.
Boundary Treatment	Plots are most commonly defined by red brick walls and heavy vegetation. Back gardens are also vegetated, providing a buffer between the settlement and arable farmland. Fields are bounded by hedgerows and trees, which provide green corridors for wildlife.
Heights & Roofline	The roofline in the Character Area varies, with building heights below the tree line and ranging from two to two and half storeys.
Public Realm	The main public space of the Character Area is the Milldown Nature Reserve. The reserve contains a rich variety of woodland, scrub, grassland and downland home to a variety invertebrates especially butterflies and moths, over sixty species of birds and two hundred types of wildflowers.
Materials	Red brick and flint are the most prevalent building materials in the Character Area.

Images

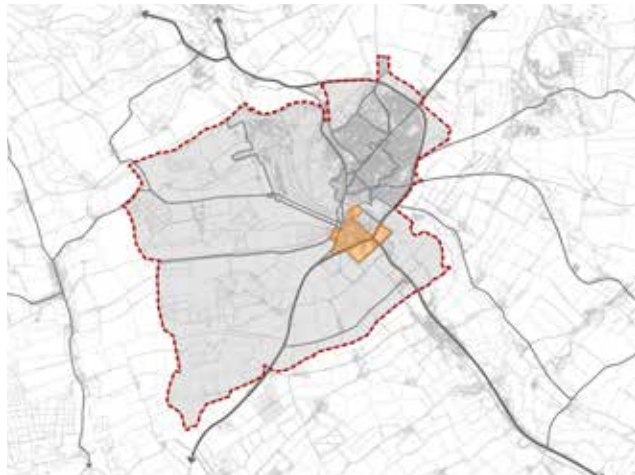

Figure 44: Detached houses with medium-sized gardens sitting in a rural atmosphere (Source: Blandford Plus NP Steering Group)



Figure 45: Lamperds Field Allotments on Salisbury Road (Source: Blandford Plus NP Steering Group)

CA7. Blandford St Mary Residential



03

Blandford St Mary Residential is located south of the town centre. It is a triangular shaped development dominated by residential uses alongside the Tesco and Homebase supermarkets.

Part of the Blandford St Mary Residential Character Area directly south of Blandford Forum is part of the wider Conservation Area designated in 1990. It contains the listed buildings adjacent to the River Stour, namely Old Ford House and St Mary's Cottage.

Land Use	The Character Area is primarily residential, with the exception of the Blandford St Mary (Primary School), St Mary's Church and Stour Inn.
Pattern Of Development	Residential areas consist of cul-de-sac streets with footpaths providing pedestrian connectivity.
Building Line/Plot Arrangement	Plots are typically large, providing generous front and back gardens. Houses are mostly terraced and semi-detached, which creates a consistent building line.
Boundary Treatment	Plots of are most commonly defined by hedges, which helps create a leafy feel to the streetscape. There are also some examples of timber fences and low brick walls.
Heights & Roofline	The roofline in the Character Area is mostly consistent, with building heights of two storeys with a hipped roof style. There are some examples of three storey buildings, which provide variation to the roofline.
Public Realm	The public realm consists of streets with grass verges. The Character Area also contains the Pigeon Close recreation ground and children's play park.
Materials	Red brick, yellow brick, white render, tiles and weatherboard are the most prevalent building materials in the Character Area.

Images



Figure 46: A row of terraced houses with hung tile and yellow brick on Bournemouth Road



Figure 47: Bungalows built with yellow brick and pitched roof with pantiles on Bournemouth Road

Figure 48: Semi- detached houses with casement window on Bournemouth Road

Figure 49: Spacious plots with deep front and back gardens on Pigeon Close

Figure 50: A view toward Birch Avenue on Railway Roundabout



CA8. Bryanston Rural Area



The stunning rural area of Bryanston is characterised by pastoral and arable farmland and ancient woodland, and a variety of Portman estate agricultural buildings and housing.

Land Use	The Character Area is primarily Pastoral and arable farmland with a range of farm buildings and former Portman estate dwellings.
Pattern Of Development	Small groups of detached, semi-detached and terraced housing are scattered sparsely within the rural landscape close to connecting roads, namely New Road, Walnut Avenue and Quarleston.
Building Line/Plot Arrangement	The orientation and setback of housing is not consistent and therefore no building line has been established.
Boundary Treatment	Plots and fields are defined by hedges and trees.
Heights & Roofline	Building heights in the Character Area are mostly consistent at two storeys and below the tree line.
Public Realm	The public realm comprises woodland and rolling fields, but with limited footpaths due to the historic character of the Portman estate farmland.
Materials	The most prevalent materials are red brick, with some blue banding, flint detailing, red clay tiled and slate roofs, with white timber sash and casement windows.

Images



F.51



F.52

Figure 51: Former Portman Estate Head Keeper's house and outbuildings in Walnut Avenue (Source: Bryanston Non-Designated Heritage Assets List, V2)

Figure 52: Quarleston House has a complex history, and was originally two cob cottages - Georgian or older. Now much modernised with extensions and in use as a single dwelling, but with very strong historic association with Portman Hunt (Source: Bryanston Non-Designated Heritage Assets List, V2)



F.53

Figure 53: Detached house with half-hipped roof fronting onto New Road, that was the former Portman Estate Game Keppers House. Off-white rendered facade and red clay-tile roof (Source: Google Earth)

CA9. Countryside of Blandford St Mary

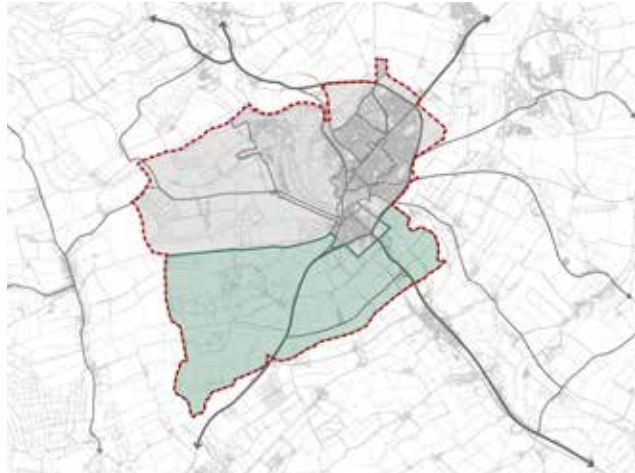

The countryside of Blandford St Mary is in the south of the Neighbourhood Area. It is filled with arable farmland, woodland, small residential areas and a well-established campsite.

Land Use	The Character Area is primarily arable farmland with the majority of buildings being for a farm use. There is a small residential settlement with a church to the east of the Character Area and campsite amongst the woodland and fields.
Pattern Of Development	The small residential area is established on a loop road joining the A350 at both ends. Housing is orientated towards the road and setback in a generous front garden.
Building Line/Plot Arrangement	The setback of housing within general front gardens is consistent and establishes a building line along Church Lane.
Boundary Treatment	Plots and fields are defined by hedges, trees and shrubs.
Heights & Roofline	Building heights in the Character Area is mostly consistent at two storeys and below the tree line.
Public Realm	The public realm consists of streets with grass verges. There are no footpaths due to the rural character of the area. The Character Area also contains routes through the countryside, which encourage an active lifestyle.
Materials	Red brick, white render and flint are the most prevalent building materials in the Character Area.

Images



Figure 54: Blandford St Mary's Church, a Grade II* listed church dated back as early as the 14th century, Church Lane (Source: <https://www.bing.com/images>)

Figure 55: Cluster of semi-detached houses with generous front and back gardens, and large setbacks from Littleton Drove (Source: Google Earth)

Figure 56: One to two-storey houses and flats along Ward's Drove, backing onto surrounding fields with little setback from the road (Source: Google Earth)

Figure 57: Views of scenic open fields and farmland along Fair Mile Road, along the northern edge of the Character Area (Source: Google Earth)





**Design Guidance and
Codes**

04

4. Design Guidance and Codes

This section sets out the principles that will influence the design of potential new development and inform the retrofit of existing properties in the Neighbourhood Area. Where possible, local images are used to exemplify the design guidelines and codes.

4.1 Introduction

The following section describes a set of design codes that have been put together based on the context and character areas of the Neighbourhood Area.

These codes will aim to guide any changes or development within the Neighbourhood Area to ensure the local character is respected whilst still allowing space for innovation within the built environment.

The structure of the design guidance and codes is detailed in **Section 4.1.2**. Other relevant policies, include those outlined in **Section 1**, should be read in conjunction with this design guidance and codes. The guidance and codes act as a support to these documents and should not be considered in isolation.

4.1.1 The importance of good design

As the NPPF (paragraph 126) notes, “good design is a key aspect of sustainable development, creates better places in which to live and work and helps make development acceptable to communities”.

Research, such as for the Government’s Commission for Architecture and the Built Environment (now part of the Design Council¹) has shown that good design of buildings and places can:

- Improve health and well-being;
- Increase civic pride and cultural activity;
- Reduce crime and anti-social behaviour; and
- Reduce pollution.

The Design Guidance and Codes seek to harness an understanding of what is good design in Blandford+ to ensure future development results in the greatest benefit to the community.

1. The Value of Urban Design, commissioned by CABE and DETR, 2001.

4.1.2 Design principles

These design codes are underpinned by a set of placemaking principles that should influence the design of future development. 'Placemaking' is about creating the physical conditions that residents and users find attractive and safe, with good levels of social interaction and layouts that are easily understood.

The placemaking principles set out in the following pages should be used to assess the design quality of future development or regeneration proposals. These key principles should be considered in all cases of future development as they reflect positive placemaking and draw on the principles set out in many national urban design best practice documents including the National Design Guide, Building for a Healthy Life and the Urban Design Compendium².

The guidelines developed in this part focus on residential environments and shopfronts. However, new development should not be viewed in isolation. The design of proposals must be informed by the wider local context and embodies a 'sense of place'.

2. [Urban Design Compendium, English Partnerships, 2000](#)

The local pattern of lanes and spaces, building traditions, materials and the natural environment should all help to determine the character and identity of a development. The first three chapters of this design guide provide a brief overview of the local context.

New development in the Neighbourhood Area should comply with the following principles:

- Thoughtfully respond to its context and the rural character areas;
- Reflect the character and appearance of any relevant Conservation Area and the significance of a heritage assets and their setting.
- Protect green spaces and contribute to the further greening;
- Promote active travel whilst reducing the dominance of parked cars on the streetscape; and
- Encourage environmentally-responsible design.

Structure of the design codes

Based on the understanding gained in the previous chapters, and in collaboration with the group, the following design codes. Future development in the Neighbourhood Area must adhere to these codes.

SL. Settlement Layout

SP. Streets and Parking

B. Built Form

EE. Environmental and Energy Efficiency

SL. Settlement Layout

CODE 1. PATTERN OF DEVELOPMENT

The pattern of development is varied throughout the Neighbourhood Area. Blandford Forum and Blandford St Mary have a nucleated development pattern with more recent development splaying outwards from the main core. On the other hand, Bryanston has a linear development pattern with large areas of undeveloped parkland and meadow.

New development proposals should consider the following principles when designing the layout of streets and plots:

- Maintain the density and scale of development within its context;
- Respect the historic, landscape and other key features of the Neighbourhood Area;
- Maintain a positive aspect onto key spaces and features;

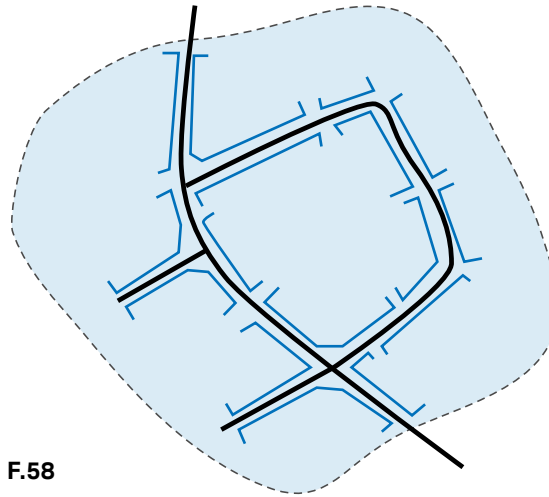

F.58

Figure 58: Diagram showing a nucleated development pattern (left) and a linear pattern development (right)

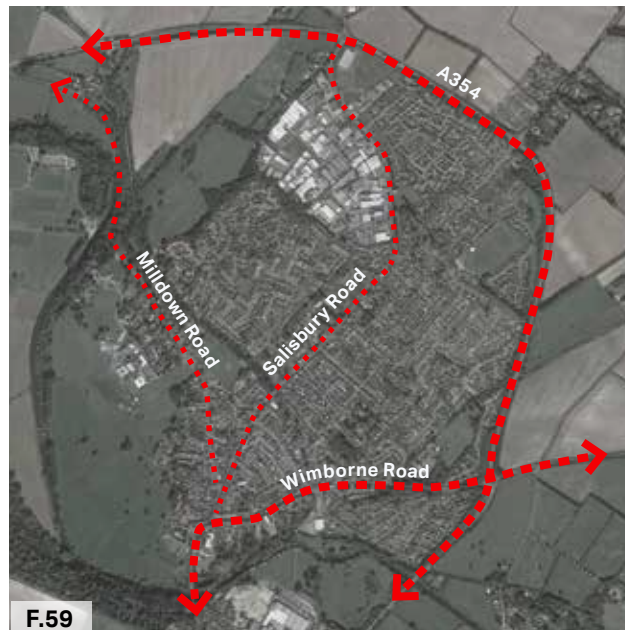
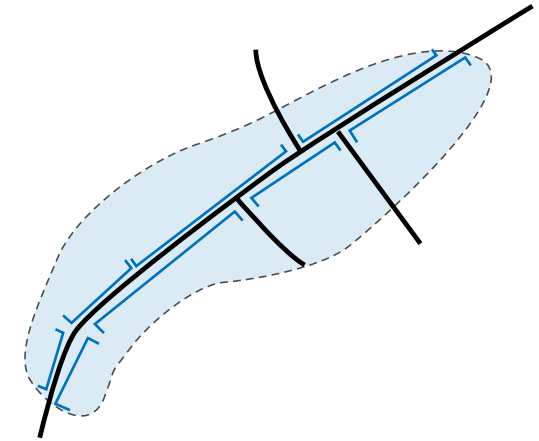

F.59

Figure 59: Nucleated pattern in Blandford Forum



F.60

Figure 60: Linear pattern development in Bryanston along The Cliff

- Linear development patterns almost always orientates inwards towards the main road and turns its back towards the landscape to the rear. Reinforce the linearity of the street with building frontages, where possible;
- Avoid development with a hard edge which imposes an abrupt transition from the settlement to the surrounding countryside. Suitable boundary treatments on the periphery of the settlement may include low walls to soft landscaped edges; and
- Burgage plots are a significant feature in the medieval town layout of Blandford Forum. They provide a worthy backdrop upon which the Georgian town sits adjacent to the river. These plots are extremely vulnerable to large scale development. Several burgage plots have been lost to development and modern housing. These medieval features should remain intact by avoiding the amalgamation of burgage plots.



F.61

Figure 61: Burgage plots within the medieval town centre between 1841-1952 (Source: <https://www.oldmapsonline.org/map/nls/101446484>)



F.62

Figure 62: Some burgage plots have been lost due to modern infill developments (Source: Google Earth)

CODE 2. LAYOUT OF BUILDING

The Neighbourhood Area owes much of its character to the historic pattern and layout of its buildings. New developments should respect the particular building patterns of the settlement in order to contribute positively to the local character. In particular:

- Parts of the Neighbourhood Area demonstrates a sense of enclosure and a continuous building line. New development should strive to knit in with the existing settlement morphology by adopting similar characteristics;
- Development should be considered strategically at the settlement level and should not be considered in isolation;
- New development should be planned to be permeable to promote active travel at all times. It is important to provide plentiful non-vehicular connections, particularly to the town centre;

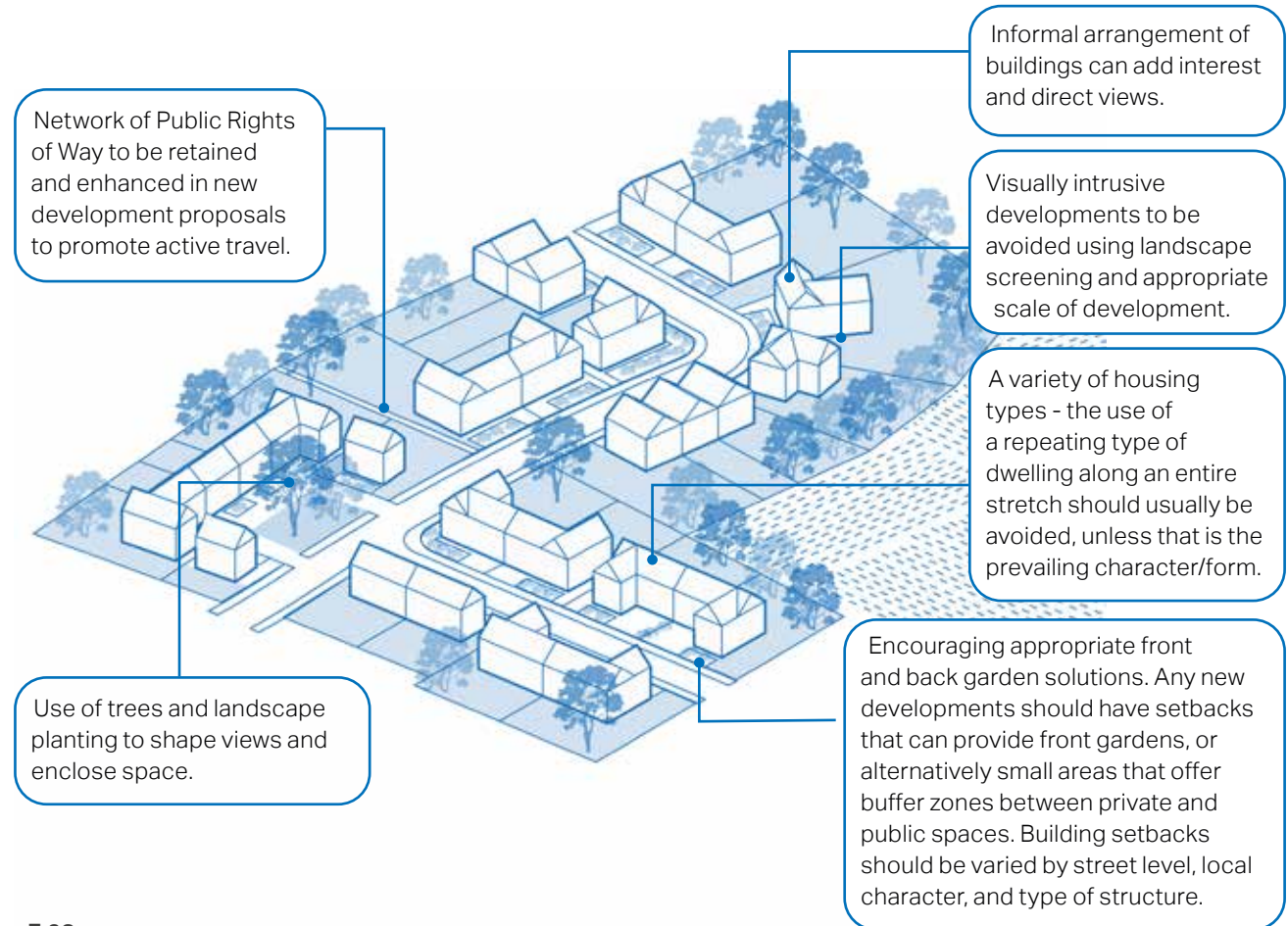

F.63

Figure 63: Diagram showing layout of building elements such as enhancing PRow networks, respecting views, and encouraging front and back gardens

- Layout, clustering and massing should take precedent from the best examples of development within the surrounding context. The adjacent images illustrate some precedent examples from the Neighbourhood Area; and
- New development should respond to site specific micro-climates and sun paths to increase the environmental comfort for building users, both internally and externally.



F.64



F.66

Figure 64: Town centre of Blandford Forum with compact two and three-storey terraced houses without any setback from the pavement



F.65

Figure 65: Two-storey terraced Portman estate cottages opposite the Model Farm complex, with broad open communal frontage, providing a rural atmosphere in Bryanston village

Figure 66: Semi-detached houses with medium-size front and back gardens

SP. Streets and parking

The following pages set out guidance that should, where appropriate, be considered when considering proposals for development within the Neighbourhood Area.

The Dorset AONB covers part of the Neighbourhood Area. Planning and development resources that support the Dorset AONB Management Plan provide further guidance for rural roads.

CODE 3. PEOPLE-FRIENDLY STREETS

It is essential that the design of new development includes streets and junctions that incorporate the needs of pedestrians, cyclists, and, if applicable, public transport users. Some guidelines for future development are:

- New streets should be linear with gentle meandering, providing interest and evolving views while helping with orientation. Routes must be laid out in a connected pattern allowing for multiple

connections and choice of routes, particularly on foot. Cul-de-sacs must be relatively short and provide onward pedestrian and cycle links;

- Within the settlement boundaries, streets must not be built to maximise vehicle speed or capacity. Streets and junctions must be designed with the safety and accessibility of vulnerable groups in mind, such as children and wheelchair users, and may introduce a range of traffic calming measures;
- Streets must incorporate opportunities for street trees, green infrastructure, and sustainable drainage. See **CODE.18** for typical drainage solutions;
- Where appropriate, cycle paths should be incorporated into street design to encourage active transport use;
- Traffic calming should be achieved by design using landscaping, street parking and building layout, and avoid traditional forms of engineered traffic calming like

humps, cushions and chicanes;

- Crossing points that are safe, convenient, and accessible for pedestrians of all abilities must be placed at frequent intervals on pedestrian desire lines and at key nodes;

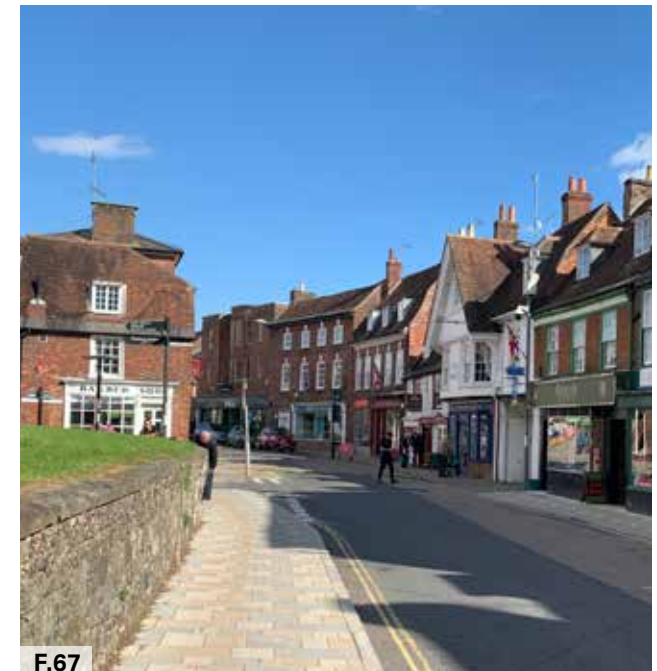

Figure 67: Wide pavements allow pedestrian flow on Market place

- Junctions must enable good visibility between vehicles and pedestrians. For this purpose, street furniture, planting, and parked cars must be kept away from visibility splays to avoid obstructing sight lines;
- At junctions with minor roads, the carriageway surface should be raised across a pedestrian crossing to prioritise pedestrian movement;
- Sufficient width of footway should be provided to facilitate a variety of mobilities, such as young family with buggies, mobility scooter, wheelchairs, etc. The Department for Transport Manual for Streets (2007)¹ states there is no maximum width for footways, it suggests that in lightly used streets, the minimum unobstructed width for pedestrians should generally be two metres; and
- New street design should include dedicated areas for cycle parking.



F.68

Figure 68: Local example of a gently meandering street with segregated footpath. The width of footway should be at least two metres to provide a safe environment for people



F.69

Figure 69: Local example of a pedestrian priority residential street in old Bryanston that hosts green verges and trees, offering a pleasant environment for pedestrians

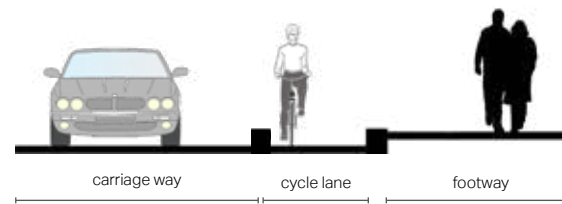

F.70

Figure 70: Cross-section illustrating a segregated cycleway

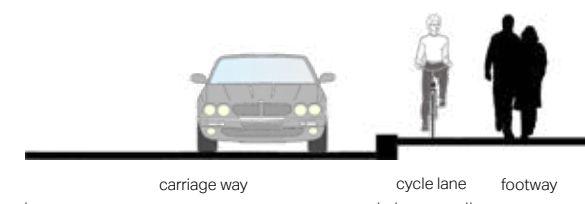

F.71

Figure 71: Cross-section illustrating a shared cycleway. The shared use footways in urban areas should be discouraged. It might be acceptable, if well-designated: alongside interurban and arterial roads with few pedestrians; at junctions or short transitions; and where high cycle and pedestrian flows occur in different times of the day (Source: Local Transport Note 1/20, July 2020)

1. Manual for Streets (2007). Available at: <https://www.gov.uk/government/publications/manual-for-streets>

Residential Streets Type 1

Some guidelines for this type of residential streets are:

- This residential streets provide access between main streets and neighbourhoods. They should emphasise the human scale and be designed for lower traffic volumes compared to primary streets;
- These streets should accommodate carriageways wide enough for two-way traffic and on-street parallel car parking bays. On-street parking may be on or accommodated on the street or inset into green verges;
- Carriageways should be designed to be shared between motor vehicles and cyclists. Green verges should be proposed along the streets; and
- Where possible, these streets should be lined by large street trees on both sides. Species of trees should have a root system that does not compromise the integrity of the pavement and underground services.

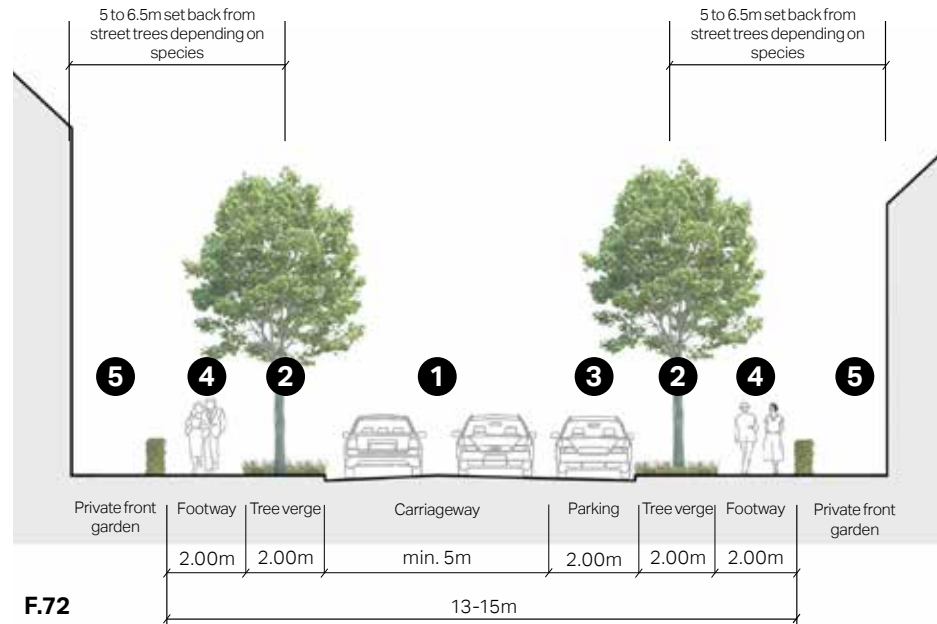

F.72

Figure 72: Cross-section to illustrate some guidelines for residential streets type 1



F.73

Figure 73: Example of a residential street type 1, Salisbury Road

1. Shared carriageway (neighbourhood traffic). Traffic calming measures may be introduced at key locations if needed.
2. Green verge with large street trees. The latter are optional but would be positive additions.
3. Parking bay (may also be inset into verges).
4. Footway - utilities typically located underneath.
5. Residential frontage with boundary hedges and front gardens.

Residential Streets Type 2

Some guidelines for this type of residential streets are:

- These streets have a strong residential character and provide direct access to residences from the previous type of streets. They should be designed for low traffic volumes and low speeds, ideally 20 mph;
- Carriageways should accommodate two-way traffic, cyclists and parking bays. These streets should also accommodate footways, with a two metre minimum width on both sides, and must be designed for cyclists to mix with motor vehicles;
- These streets should be formed with a high degree of built form enclosure, with consistent building lines and setbacks;
- Small street trees should be provided with suitable gaps, wherever possible.

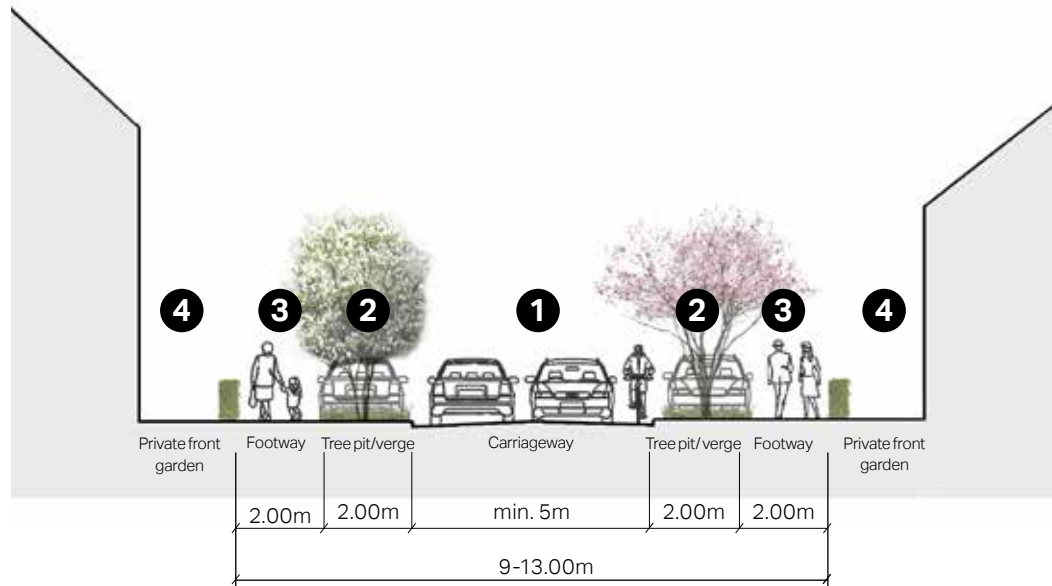

F.74

Figure 74: Cross-section to illustrate some guidelines for residential streets type 2



F.75

Figure 75: Local example of a residential streets type 2, Chapel Gardens in Blandford Forum

1. Carriageway should accommodate both vehicles and cyclists (local access). Tree verge or pit with small trees. The latter are optional but would be positive additions. Parking bays on both sides of the carriageway to alternate with trees to avoid impeding moving traffic or pedestrians.
2. Footway.
3. Residential frontage with boundary hedges and front gardens.
4. Residential frontage with boundary hedges and front gardens.

Edge Lanes

Some guidelines for this type of residential streets are:

- All the edges of new development areas should be served by continuous Edge Lanes to provide high level of connectivity;
- Edge lanes are low-speed and low-traffic streets that front houses with gardens on one side and a green space on the other. Carriageways typically consist of a single lane of traffic in either direction, and are shared with cyclists;
- The lane width can vary to discourage speeding and introduce a more informal and intimate character. Variations in paving materials and textures can be used instead of kerbs or road markings; and
- Edge lanes should be continuous providing high level of connectivity and movement. Cul-de-sacs must be avoided.

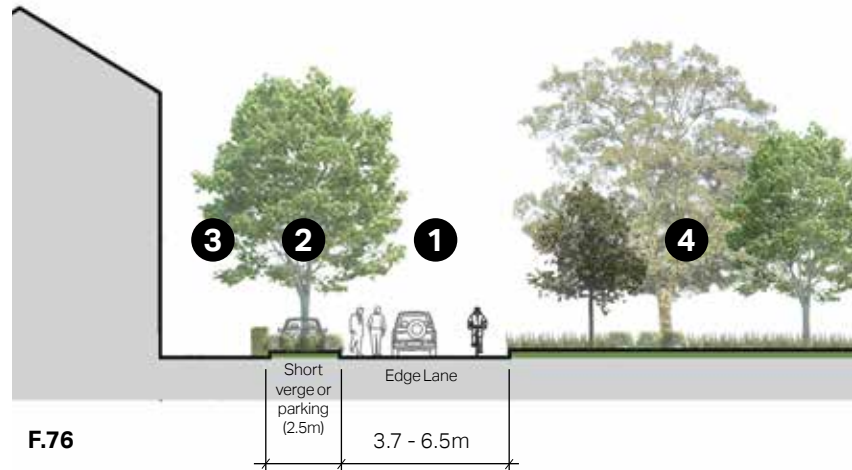

F.76

Figure 76: Cross-section to illustrate some guidelines for edge lanes

1. Shared lane (local access) - width to vary.
2. Green verge with trees. It is optional but would be positive additions. Parking bays to be interspersed with trees to avoid impeding moving traffic or pedestrians.
3. Residential frontage with boundary hedges and front gardens.
4. Green space and potential for implementing swales into the landscaping.



F.77



Figure 77: Examples of an edge lane. Left picture is Dewenthorpe and the right picture is Poundbury

CODE 4. ACTIVE TRAVEL

There are various lanes, closely enclosed by buildings. These lanes connect the surrounding spaces to East Street. Apart from these, there are good number of footpaths and cycleways within the Neighbourhood Area. Increasing the number of residents walking and cycling around the town and other parishes is an important part of improving health and the quality of their experience.

- Where there is a choice, new development areas that generate the least amount of car movements and are within a comfortable walking distance of local services should be prioritised. This will help to promote active travel, an important feature of 'liveable' neighbourhoods;
- New development should ensure that pedestrian and cycle routes are incorporated into new designs ensuring that the option to travel on foot or by bike is incentivised. These routes should

form an active travel network by linking to key services along Market Place, East Street, The Cliff and Bournemouth Road and to other existing routes;

- Users of public and private space are varied and include disabled users, parents/carers with buggies and young children. It is important for these users to be catered for when designing new development;
- Walking routes along a roadway should provide safety from vehicles on the road. This requires a footway, grass verge or pavement that is wide enough (depending on the road types it could be between 2-2.6 metre) to ensure pedestrians do not conflict with vehicles; and
- Walking routes should not pass through hazardous areas such as fields with dykes, ditches or areas of flooding.



F.78

Figure 78: Trailway in Blandford Forum being used as walking and cycling paths

CODE 5. LEGIBILITY AND WAYFINDING

It is important for new development to help people to orientate themselves, particularly for people with dementia and related cognitive and sensory challenges. Signposts, landmarks and a simple layout of public spaces and streets supports legibility and wayfinding. Some guidelines for new development to enhance legibility and wayfinding are:

- A familiar and recognisable environment makes it easier for people to find their way around. Obvious and unambiguous features should be designed in new development;
- Buildings which are located at corners, crossroads or along a main road could play a significant role in navigation;
- At a local level, landmark elements could be a distinctive house, public art, or even an old and sizeable tree;

- New signage design should be easy to read. Elements like languages, fonts, text sizes, colours and symbols should be clear and concise, and avoid confusion;
- Signage can also help highlight existing and newly proposed footpaths and cycle lanes, encouraging people to use them more;
- Signage should be strategically located to signalise gateways and access points, creating connections with important places and destinations; and
- Signage elements and techniques should be appropriate to the character of the area and be a nice fit to the existing architectural style and details.
- Signage be used in a manner which avoids unnecessary street clutter.



F.79

Figure 79: Corn Exchange as a landmark on Market Place built with distinctive materials



F.80

Figure 80: Different signage for the town centre (right) and for more informal spaces (left)

CODE 6. CAR PARKING SOLUTIONS

Parking areas are a necessity of modern development and should be delivered as an exercise of placemaking. They do not need to be unsightly or dominate views towards housing. Some guidelines for new development to consider are:

- When placing parking at the front of a property, the area should be designed to minimise its visual impact and to blend with the existing streetscape and materials. The aim is to keep a sense of enclosure and to break the potential of a continuous area of car parking in front of the dwellings. This can be achieved by means of walls, hedging, planting, and the use of quality paving materials;
- When needed, residential car parking can be translated into a mix of on-plot side, front, garage, and courtyard parking, complemented by on-street parking;
- For family homes, cars should be placed at the side (preferably) or front of the property. For small pockets of housing, a rear court is acceptable;
- Car parking design should be combined with adequate landscaping to minimise the presence of vehicles; and
- Parking areas and driveways should be designed to improve impervious surfaces, for example, through the use of permeable paving.



F.81

Figure 81: On-street parking can be softened by planting more trees, planters, green verges



F.82

Figure 82: On-plot parking with garage

ON-STREET PARKING

On-street parking is the only parking option for several dwellings within the Conservation Areas. In order to reduce the visual impact of parked cars on the street, on-street parking as the only means of parking should either be avoided in future development or softened by landscaping wherever possible.

- On-street parking must be designed to serve as informal traffic calming but avoid impeding the flow of pedestrians, cyclists, and other vehicles;
- On low-traffic residential streets or lanes that are shared between vehicles and pedestrians, parking bays can be clearly marked using changes in paving materials instead of road markings; and
- Opportunities must be created for new public car parking spaces to include electric vehicle charging points. Every opportunity must be taken to integrate charging technologies into the fabric of

the road and street furniture in both the public and private realm.

- Within conservation areas, additional consideration must be given to ensure that integrated EV charging points are discrete and compliment their historic setting.

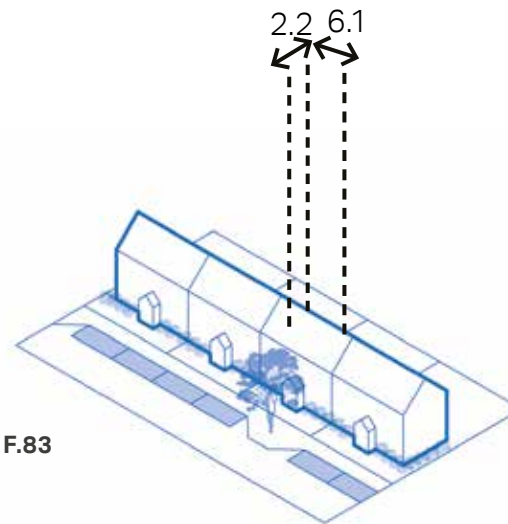
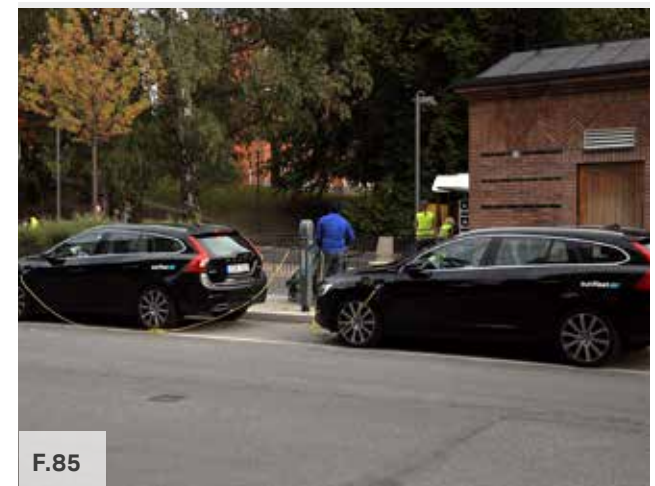

Figure 83: Illustrative diagram showing an indicative layout and minimum dimensions of on-street parking



F.84



F.85

Figure 84: On- street parking on Market Place

Figure 85: Inset on-street parking with electric vehicle charging points

ON-PLOT SIDE OR FRONT PARKING

- Parking provided on driveways directly in front of dwellings should be restricted due to the visual impact that cars have on the street. Therefore, a maximum of two dwellings in a row will be permitted to provide parking in this way. Front gardens should be a minimum depth of six metres to allow movement around parked vehicles and also be well screened with hedgerows when providing parking space to the front of a dwelling;
- Parking being provided on a driveway to the side of a dwelling should be of sufficient length (five metre minimum) so that a car can park behind the frontage line of the dwelling. This will reduce the visual impact that cars will have on the street scene. When parking is provided to the side of a dwelling a minimum front garden depth of three metres should be provided; and
- Where possible, electric vehicle charging points should be incorporated into on-plot parking in new developments to promote more sustainable modes of transport.

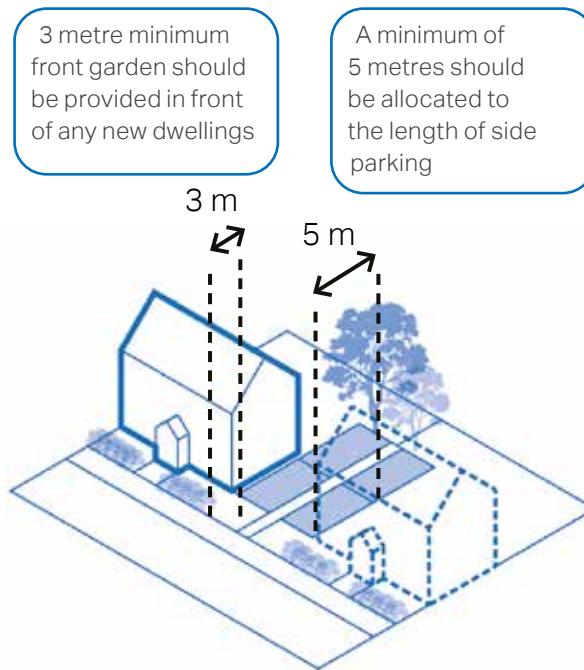

F.86

A minimum of 6 metres should be allocated to the length of on-plot parking

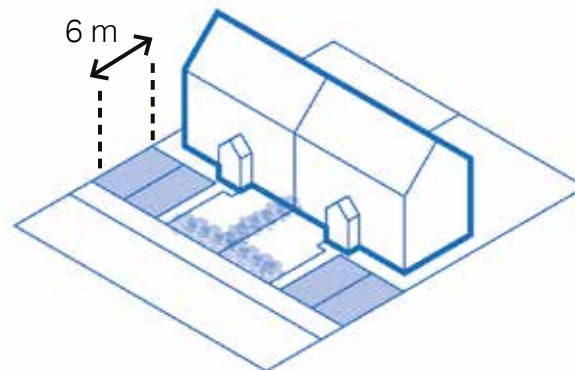

F.87

Figure 86: Illustrative diagram showing the indicative layout of and minimum dimensions of on-plot side parking

Figure 87: Illustrative diagram showing an indicative layout and minimum dimensions of on-plot front parking

Figure 88: On-plot side parking on Elizabeth Road

Figure 89: On-plot parking on Preetz Way and partially screened by a hedgerow



GARAGE PARKING

Parking being provided in a garage to the side of a dwelling should be in line with, or slightly set back from the frontage line of the existing dwelling. This is to ensure garages are in keeping with the character of the existing settlement and will reduce the visual impact of cars on the street. Garages should also provide sufficient room for cars to park inside them as well as providing some room for storage and cycle storage. The minimum internal dimensions of a garage should therefore be 7 x 4 metres.

- Where possible cycle parking should be accessed from the front of the building either in a specially constructed enclosure or easily accessible garage;
- The design of any enclosure should integrate well with the surroundings; and
- Bikes must be wheeled out easily without having to move the vehicle.

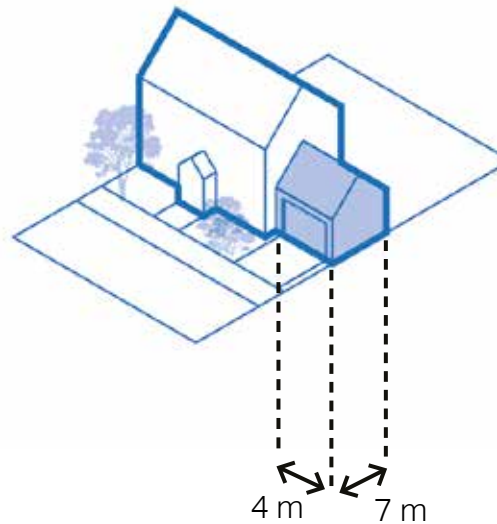

F.90

The minimum internal dimensions of a garage should be 7m x 4m

Figure 90: Illustrative diagram showing an indicative layout of on-plot garage parking



F.91

Figure 91: Garage parking on Preetz Way screened by sufficient landscaping

PARKING COURTYARD

- This parking arrangement can be appropriate for a wide range of land uses. It is especially suitable for terraces fronting busier roads where it is impossible to provide direct access to individual parking spaces;
- Ideally all parking courts should benefit from natural surveillance;
- Parking courts should complement the public realm; hence it is important that high-quality design and materials, both for hard and soft landscaping elements, are used; and
- Parking bays must be arranged into clusters with groups of four spaces as a maximum. Parking clusters should be interspersed with trees and soft landscaping to provide shade, visual interest and to reduce both heat island effects and impervious surface areas.

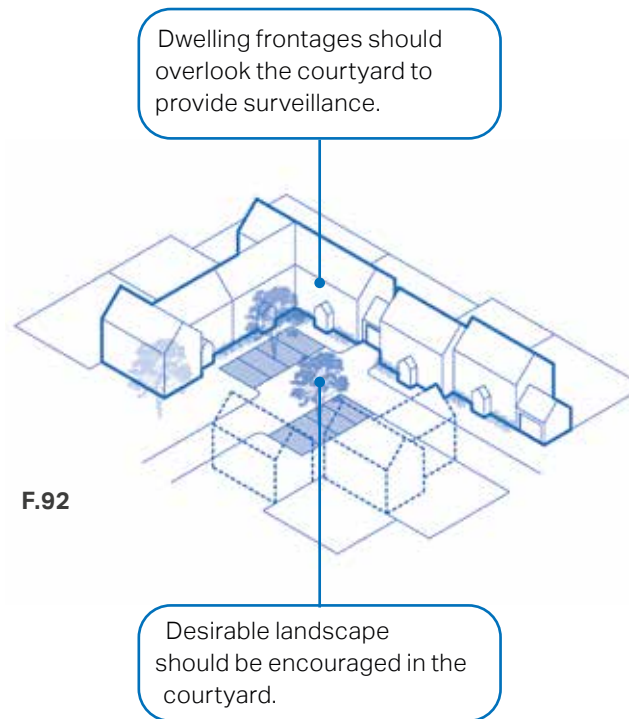

Figure 92: Illustrative diagram showing an indicative layout of parking courtyards



Figure 93: Courtyard parking on Fairfield Road. The courtyard parking can be softened by proposing adequate landscaping

CODE 7. INCLUSION OF STRATEGIC GREEN INFRASTRUCTURE AND LANDSCAPING

The Neighbourhood Plan designates a Green Infrastructure Network to promote sustainable movement and ecological connectivity through the town and adjacent parishes. The network includes local green spaces, informal open spaces, allotments, playing fields, off-street footpaths/cycleways, children's play areas, woodland and land of biodiversity value. Refer to the Neighbourhood Plan for more information.

Landscaping, green spaces and trees provide shading and cooling, absorb carbon dioxide, act as habitats and green links for species, reduce air pollution and assist water attenuation and humidity regulation. For people, they help alleviate stress and anxiety, help with recovery from ill-health and create a sense of positive mental health and well-being. In addition, they add life to the landscape and help shape and add character to open spaces.

The following guidelines focus on the design aspects and appearance of planting and trees in private gardens as well as public open spaces and streets, which contribute to establishing the Green Infrastructure Network.



F.94

Figure 94: An indicative diagram showing green spaces and landscape planting

IMPROVE GREEN INFRASTRUCTURE NETWORK

The designated Green Infrastructure Network should be maintained and enhanced where possible. There are opportunities to green the existing streets and courtyards to complete the Green Infrastructure Network and to contribute to the biodiversity connectivity.

- Green Infrastructure Network should link open spaces, settlements and wide rural areas together;
- Sustainable urban Drainage System (SuDS) could be introduced when possible and incorporated in the design of green corridors;
- Developments should front onto and have access from the Green Infrastructure Network;
- Green Infrastructure Network could contain some formal provision - such as a Neighbourhood Equipped Area of

Play (NEAP), playing fields and an area for active recreation - to improve the health and well-being of individuals and promote inclusive communities; and

- Existing streets can be retrofitted by introducing verges or street trees to complete the Green Infrastructure Network connectivity and contribute to the biodiversity network.

PLANTING STANDARD

- Respect existing Tree Preservation Orders (TPO) and mature trees, incorporating them into the new landscape design and using them as accents and landmarks, where appropriate;
- Consider canopy size when locating trees. Reducing the overall number of trees but increasing the size of trees is likely to have the greatest positive long-term impact;
- Size of tree pits should allow sufficient soil around the tree. Ensure tree stems

are in the centre of the verge to provide a one metre clearance of the footway or carriageway;

- New trees should be added to strengthen vistas, focal points and movement corridors, while retaining clear visibility into and out of amenity spaces. They should, however, not block key view corridors and vehicular circulation sight lines;
- New trees should be integrated into the design of new developments from the outset rather than left as an afterthought to avoid conflicts with above- and below-ground utilities;
- To ensure resilience and increase visual interest, a variety of tree species is preferred over a single one. Tree species should be chosen to reflect the prevailing landscape character, soil conditions and the associated mix of native species of local provenance, but should also have regard to climate change, environmental/habitat benefits, size at maturity and ornamental qualities;

- Regulations, standards, and guidelines relevant to the planting and maintenance of trees include:
 - Trees in the Townscape: A Guide for Decision Makers;¹
 - Tree Species Selection for Green Infrastructure;² and
 - BS 8545:2014 Trees: from nursery to independence in the landscape - Recommendations.³

¹ Trees & Design Action Group (2012). *Trees in the Townscape: A Guide for Decision Makers*. Available at: http://www.tdag.org.uk/uploads/4/2/8/0/4280686/tdag_treesinthetownscape.pdf

² Trees & Design Action Group (2019). *Tree Species Selection for Green Infrastructure*. Available at: http://www.tdag.org.uk/uploads/4/2/8/0/4280686/tdag_treespeciesguidev1.3.pdf

³ British Standards Institution (2014). *BS 8545:2014 Trees: from nursery to independence in the landscape - Recommendations*. Available at: <https://shop.bsigroup.com/ProductDetail/?pid=000000000030219672>

GIVE SPATIAL ENCLOSURE AND PROVIDE SCREENING AND PRIVACY

The use of hedges, hedgerow trees and walls contributes to the strong character of the area and a sense of enclosure. To respect the existing context, both the building and the boundary feature should be consistent with the prevailing character, although there should be some allowance for some variation to provide added visual interest.

Tree-lined streets and landscaping with boundary treatments can help to enhance the public realm and complement the character of the place

Climbing plants can add interest to walls and features

Where a looser pattern of development is proposed, visual continuity and well-defined public realm can be achieved by the careful positioning of walls and landscaping

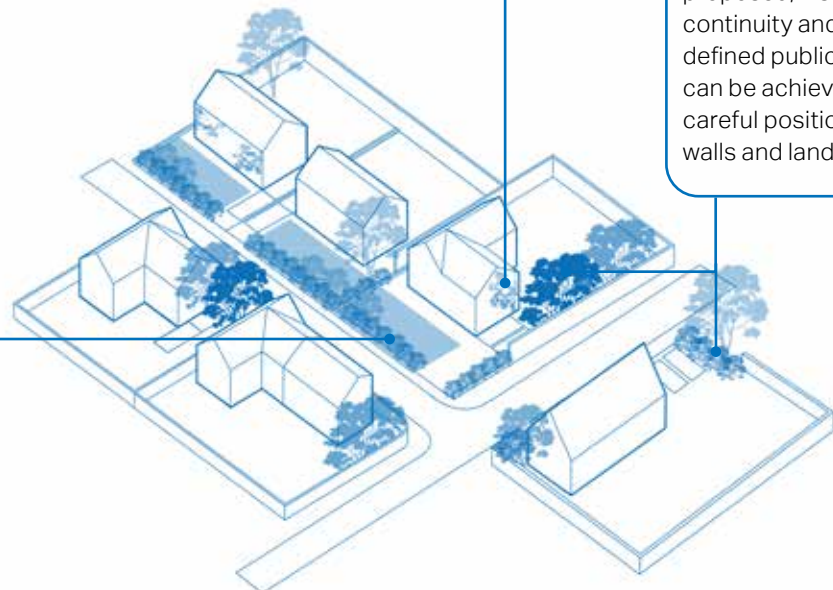

F.95
Figure 95: Diagram showing trees and landscaping that complement the public realm and create a sense of enclosure

- Existing hedges, hedgerow, green verges, trees and walls should, wherever appropriate, be retained to contribute to this sense of enclosure. Additional or replacement hedges and trees should be planted to maintain the continuity of existing hedges; and
- Where appropriate and feasible, any new developments should have setbacks that allow for front gardens or else a small area to provide a planted buffer zone between the private space and public space.

FORM FOCAL POINTS AND FRAME VIEWS

In addition to the intrinsic value of trees, they can also have a practical use value. In a small-scale open space, trees provide a focal point of interest.

COMPLEMENT THE PUBLIC REALM AND ENHANCE THE BUILT ENVIRONMENT AND LOCAL IDENTITY

Planting can make an appreciable difference to the appearance of an area, as well as adding to the local identity.

- New development should use boundary features which are complementary to the street and enhance the character of the village. The use of trees, hedges and planting in publicly visible areas, including edges and interfaces, should be encouraged; and
- Climbing plants are good at screening features such as garages, blank walls and fences.



F.96

Figure 96: A mature tree as a focal point on Fisher's Close



F.97



F.98



F.99



F.100

Figure 97: Maintain and enhance the existing green verges in Bryanston

Figure 98: River Stour and the natural environment provide a significant view on Stour Meadow

Figure 99: A view towards Bryanston School

Figure 100: Woodhouse Garden, a well-maintained green space at the heart of town centre on The Close

CODE 8. STREET LIGHTING AND DARK SKIES

The 'dark skies' character of the countryside should be protected. Dark skies benefit both people and wildlife.

Any new development should minimise impact on the existing 'dark skies' within the settlements and reduce light pollution that disrupts the natural habitat and human health.

The following guidelines aim to ensure there is enough consideration given at the design stage:

- Street lighting should be avoided within areas of public realm, in line with existing settlement character;
- Ensure that lighting schemes such as LED streetlights will not cause unacceptable levels of light pollution, particularly in intrinsically dark areas. These can be areas very close to the countryside or where dark skies are enjoyed;

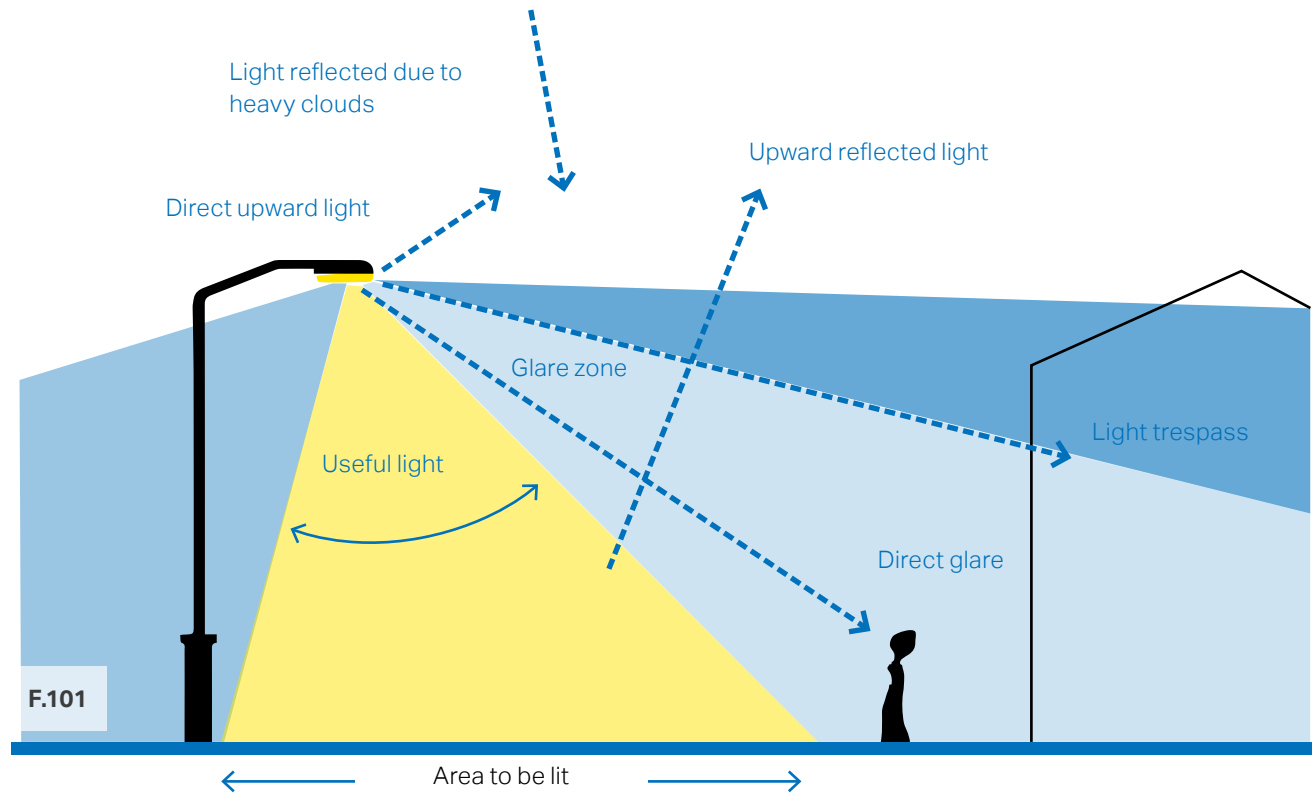

Figure 101: Indicative diagram to illustrate the different components of light pollution and what 'good' lighting means

- Residential lighting i.e. on or around the property; is to be sympathetic with the location and be of low light levels so as to avoid excessive light pollution;
- Consider lighting schemes that could be turned off when not needed ('part-night lighting') to reduce any potential adverse effects; i.e. when a business is closed or, in outdoor areas, switching off at quiet times between midnight and 5am or 6am. Planning conditions could potentially be used to enforce this. External lighting schemes should be PIR controlled and unnecessary lighting avoided;
- Impact on sensitive wildlife receptors throughout the year, or at particular times (e.g. on migration routes), may be mitigated by the design of the lighting or by turning it off or down at sensitive times;
- Glare should be avoided, particularly for safety reasons. This is the uncomfortable brightness of a light source due to the excessive contrast between bright and dark areas in the field of view. Consequently, the perceived glare depends on the brightness of the background against which it is viewed. Glare is affected by the quantity and directional attributes of the source. Where appropriate, lighting schemes could include 'dimming' to lower the level of lighting (e.g. during periods of reduced use of an area, when higher lighting levels are not needed);
- The needs of particular individuals or groups should be considered, where appropriate (e.g. the safety of pedestrians and cyclists); and
- Any new developments and house extensions designs should encourage the use of natural light sources.

CODE 9. SHOPFRONTS

Shops make a significant contribute to the distinguished character of the town and village centres of the Neighbourhood Area. Any shopfronts should demonstrate adherence to the The North Dorset Guide to Shopfront Design 2014¹. This guide sets out fundamental principles for architectural elements, which must be addressed by development proposals. It also sets out the general considerations for the streetscene, building as a whole and details. This design guide does not repeat these relevant fundamental principles and general considerations.

In addition to consider the guide, the development of new shopfronts should take account of rhythm and character of the street such as the width of building, the horizontal or vertical emphasis, the variety of style and architecture of the building itself. Where the shopfront continues to another building, a change in its design may be required.

¹ [North Dorset Guide to Shopfront Design 2014](#)



F.102

Figure 102: A good example of shopfront design in the Neighbourhood Area

B. Built Form

The following section outlines guidelines that should be considered by developers when creating new development within the Neighbourhood Area. Some of the following guidance is directed at development on existing plots, such as infill developments, though many can be applied to both new and existing development.

In general, the form of historic parts areas in the Neighbourhood Area consist of medium-size plots and dwellings. However, burgage plots are also a significant feature within the historic core of the town. While this is appropriate when development or redevelopment occurs in those areas, newer development areas should establish a coherent form in accordance with contemporary best practice. That is, there should be a proportional relationship between the plot size, dwelling and spaces between the dwellings. The following illustrative diagrams show this intention and new proposals would need to demonstrate that this has been observed.

The structure of the following codes generally starts with policies on a larger scale and subsequently moves to codes related to specific built form details.



F.103

Figure 103: A detached house with feature gable on Preetz Way

CODE 10. DEFINE FRONT AND BACK GARDENS

Consideration for the ratio of garden space to built form within the plot is critical to ensure that the sense of openness and green space within the town and adjacent parishes is maintained.

There are different garden dimensions in each of the Character Areas. The majority have front and back gardens ranging between 3-9 metres and 9-14 metres, respectively. Bryanston is an exception to this, which has more generous gardens. The average front and back garden sizes in Bryanston are between 10-15 metres and 20-35 metres, respectively.

In Blandford Forum, back gardens are enclosed by brick walls or wooden fences, whilst front gardens are often open-plan.

The front and back gardens in Blandford St Mary are small. The front gardens of the semi-detached houses have access to the footpath and are generally the length of a car. Most provide parking for one car in the front setback and are boarded by hedges.

Bryanston has small front and secluded back gardens. Generally, back gardens should be a minimum depth of 10 metres and provide a minimum area of 50 square metres of useable amenity space.

North facing back gardens should exceed 10 metres in length to ensure sunlight is maximised.

In general, avoid replacing green spaces with infill development or backland development (see **CODE 14**).

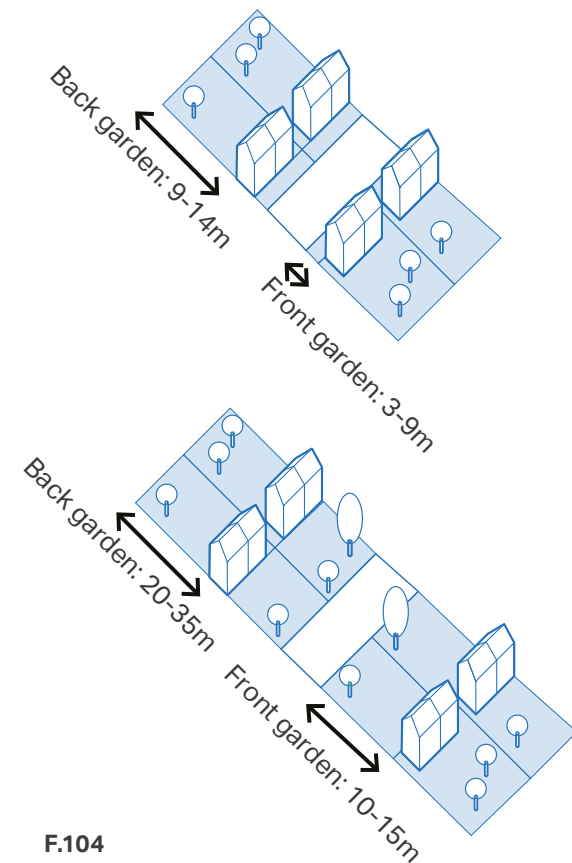

F.104

Figure 104: Different proportion of green space varied. From top (CA1, CA2, CA3, CA5) and bottom (The Cliff in Bryanston)

CODE 11. RESPECT MASSING, ROOFSCAPE AND HEIGHT

The average building heights in Blandford Forum, Blandford St Mary and Bryanston is 2.5, 2 and 1.5 storeys, respectively.

- Massing, roofscape and height should take into account the character of any relevant Conservation Area, and the significance of any heritage assets. For example, the three storey Brewery Site is an unsympathetic local example;
- Roofs in the area tend to be pitched, with some hipped examples, which should be reflected by new development. The use of red, dark pink tile and slate are widespread and should be the primary roofing material for new development;
- Subtle variations in height should be created by altering eaves and ridge heights to add visual interest. The bulk and pitch of roofs, however, must remain sympathetic to the tree canopy,

the local vernacular, and the low-lying character of the town. Another way to achieve visual interest could be by varying frontage widths and plan forms;

- The massing of new buildings must ensure a sufficient level of privacy and access to natural light for their occupants and avoid overshadowing existing buildings. New buildings must not significantly compromise existing property views of open and green spaces and big skies;
- Innovation which explores the integration of green roof should be encouraged;
- The scale of the roof should always be in proportion to the dimensions of the building itself. Flat roofs for buildings, extensions, garages should be avoided; and
- Chimney type and height should be congruent with the typical chimney precedent examples.



F.105

Figure 105: Brewery redevelopment is not in keeping with adjacent development blocking views to the countryside and affect adjacent listed building (Source: Blandford Plus NP Steering Group)



F.106

Figure 106: Subtle variation in height and use of dormers and chimney stacks add visual interest to the streetscape on Market Place

CODE 12. ESTABLISH A CONSISTENT PROPERTY BOUNDARY

- Buildings should front onto streets. The building line can have subtle variations in the form of recesses and protrusions, but will generally be consistent;
- Buildings should be designed to ensure that streets and/or public spaces have good levels of natural surveillance from adjacent buildings. This can be achieved by placing ground floor habitable rooms and upper floor windows facing the street;
- Natural boundary treatments should reinforce the sense of continuity of the building line and help define the street, appropriate to the character of the area. They should be mainly continuous hedges and low walls, as appropriate, made of traditional materials found elsewhere in the Neighbourhood Area;

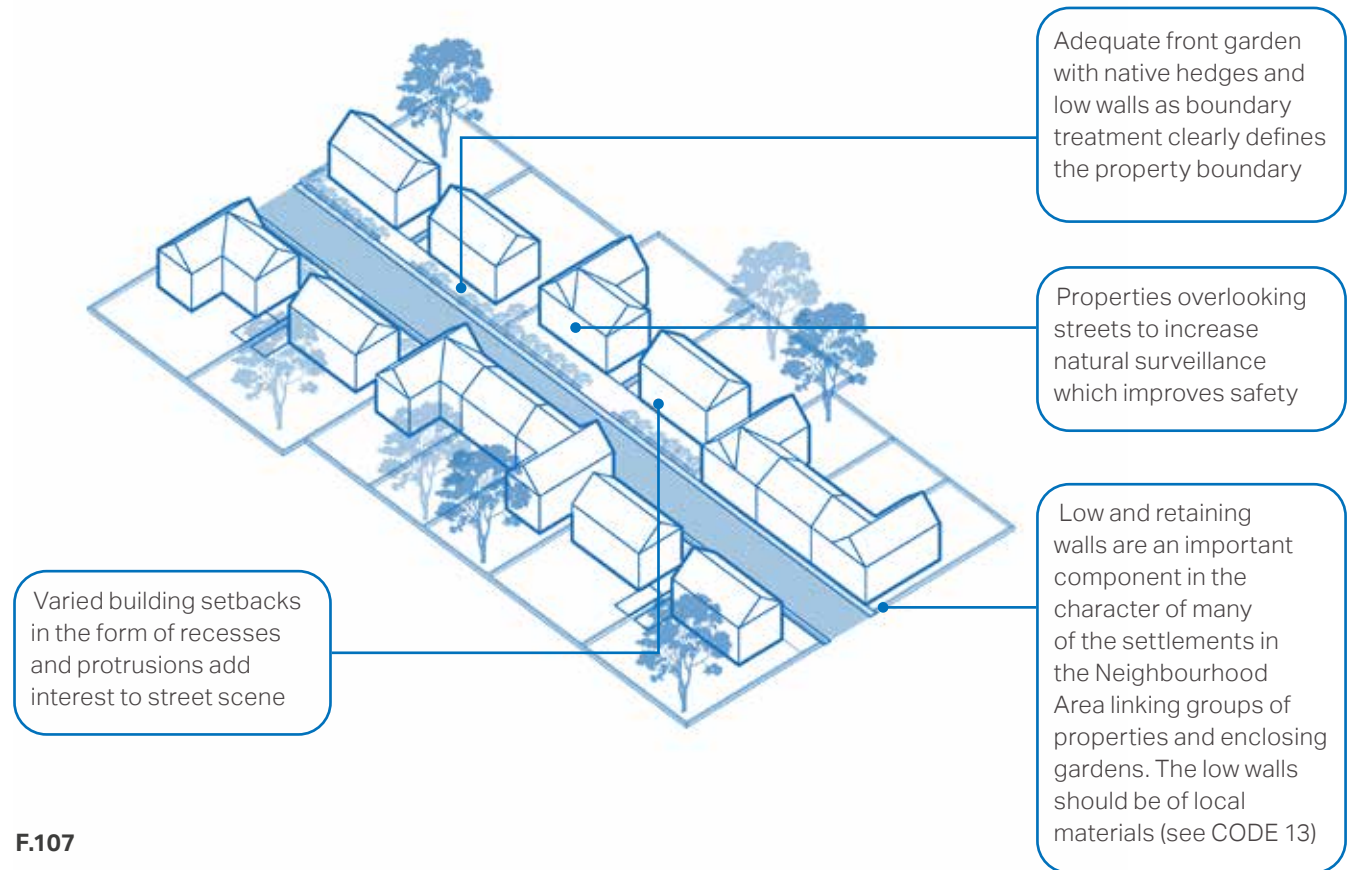

Figure 107: Illustrative diagram showing boundary treatments

- Front gardens/soft planted shallow setbacks should be provided in most instances, although it is recognised that there are some parts of the Neighbourhood Area where the prevailing character and form is one where buildings sit to the back of the footway/ highway;
- If placed on the property boundary, waste storage should be integrated as part of the overall design of the property. Landscaping could also be used to minimise the visual impact of bins and recycling containers; and
- Locally distinctive landscape features and planting, such as low wall boundary and hedges of native species should be used in new development to define boundaries. Any material that is not in keeping with the local character should be avoided.



F.108

Figure 108: Shops along Salisbury Street without boundary treatments



F.110

Figure 110: Two-storey detached house with shrubs and hedges as boundary treatment on Preetz Way



F.109

Figure 109: Hedges, shrubs and deep green verges are the predominant boundary treatments in old Bryanston. These give a feeling of openness and should be maintained and enhanced



F.111

Figure 111: Low wall and fencing as boundary treatment on Salisbury Road

CODE 13. RESPECT THE LANDMARKS AND IMPORTANT VIEWS

New development proposals should not be visually intrusive. This should be achieved through appropriate scaling and design, including landscape screening, where appropriate;

- Where possible, scenic values and tranquility of countryside views should be retained in future development;
- Where appropriate, future development proposals should incorporate landscape and built features to create landmarks, helping with legibility; and
- New development proposals should maintain visual connections to the surrounding landscape and long views out of the settlement. Development density should allow for spaces between buildings to preserve views of countryside beyond and maintain the perceived openness of the settlement. The views towards The Cliff should be respected; and

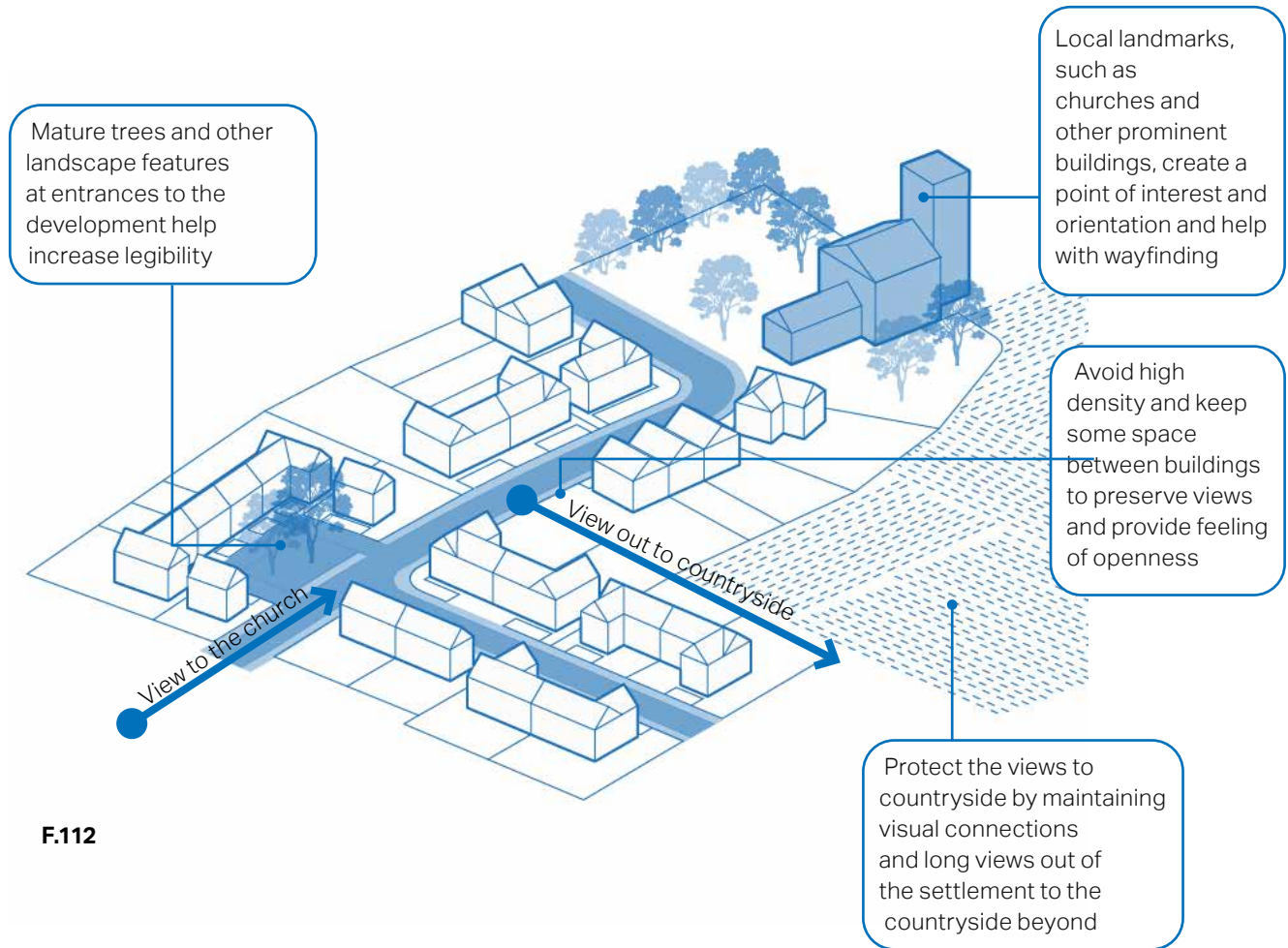

F.112

Figure 112: Diagram showing landmarks and views

- Creating short-distance views broken by buildings, trees or landmarks helps to create memorable routes and places, and easily intelligible links between places. New developments should be oriented to maximise the opportunities for memorable views and visual connectivity.
- New development must enhance, not negatively impact on, 'key views' identified within the Dorset Councils Partnership's 'Conservation Area Appraisal'.



Figure 113: Corner building acts as landmark

Figure 114: Pump House, a grade I listed building, just next to St Peter and St Paul's Church which is a focal point on Market Place

Figure 115: Corn Exchange with white stone and distinctive architecture details is a landmark on Market place

Figure 116: Mature trees and significant landscape in Bryanston School

CODE14. INFILL DEVELOPMENT

Backland development or plot infill is development on land of an existing dwelling. In the case of Blandford, there have been recent instances of infill/backland development that has been out of context in terms of scale, form and material palette. There is a risk that this sort of development will continue to come forward, which may harm the historic core of the town where the burgage pattern development is located.

Any new backland development should ensure that the spacing requirements set out within this code are met and that the density, scale and appearance of the development reflects its immediate context and reduces impacts to the amenity of existing properties.

Tandem development is a form of backland development where a new dwelling is placed immediately behind an existing dwelling and is serviced by the same vehicular access. Tandem developments will generally be

unacceptable due to the impact on the amenity of the dwelling at the front of the site.

Where a proposal involves residential development on land behind an existing frontage or placing of further dwellings behind existing dwellings within the site, the proposal should demonstrate the privacy of existing and future residents and adequate means of access, and it should not extend beyond the limit of the settlements.

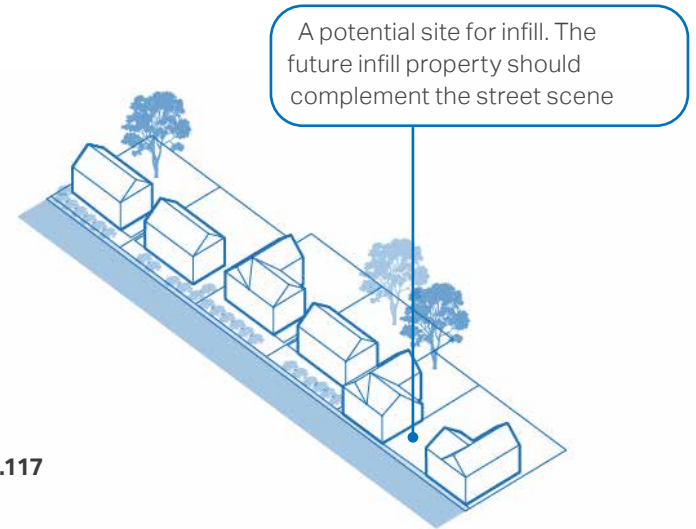

F.117

New building lines should be consistent with existing properties. Some places in the Neighbourhood Area have linear or regular meandering arrangements of buildings while others have random and irregular patterns. The infill should also reflect the surrounding context in terms of form, materials and scale

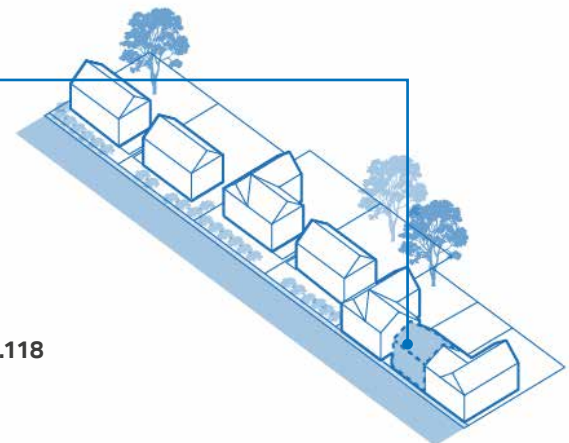

F.118

Figure 117: An indicative diagram highlighting a site before infill

Figure 118: An indicative diagram highlighting a site after infill



F.119



F.120

Figure 119: A positive example of infill development on Salisbury Road. The sympathetic architecture and materials used on the new infill development

Figure 120: Unsympathetic architecture and materials in Forum cafe on Salisbury Street (Source: Blandford Plus NP Steering Group)

Figure 121: Diagram showing backland development

Figure 122: Diagram showing tandem development which will generally be unacceptable due to unacceptable erosion of privacy and amenity

Addressing any issue of privacy and means of access when new infill proposal come forward

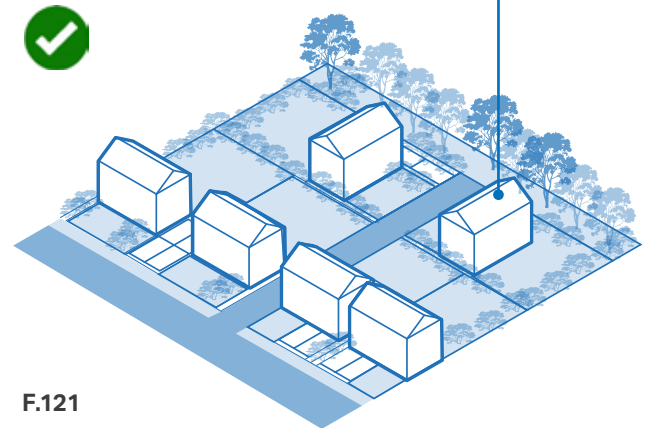

F.121

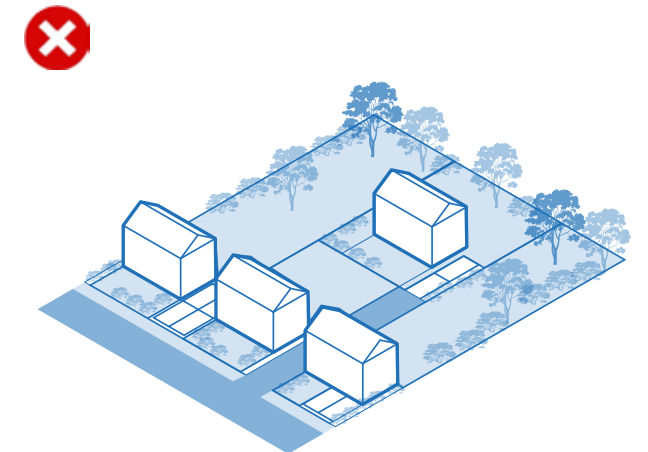

F.122

Infill plot development should take precedent from good examples within the surrounding architectural context. Poor contextual precedents should not set the standard. Therefore, the code stipulates that this type of development within the existing settlement will be supported if it adheres to the following principles:

SETTING AND CHARACTER

Infill development should complement the street scene and rural setting into which it will be inserted.

BUILDING PATTERN

Development should align with the spatial layout and pattern of the settlement in terms of the sizes of plots and position of houses within those plots.

SCALE AND MASSING

The height of development should take into consideration the surrounding context. The scale of any infill or backland development should be informed by adjacent dwellings within the streetscene, which will lead to a maximum of two storeys in most of the Neighbourhood Area outside the town centre, where three or four storeys may be appropriate.

The ratio of garden space to built form within the overall plot is important to ensure that the sense of openness and green space within the settlement is maintained (see **CODE 10**).



F.123

Figure 123: Semi-detached infill development. The dormers do not match and spoil the symmetry of a row of identical houses on Kings Road (Source: Blandford Plus NP Steering Group)



F.124

Figure 124: A positive example of infill development. New properties on site of Magistrates Court mirrors the houses opposite on Salisbury Road (Source: Blandford Plus NP Steering Group)

PLOT BOUNDARY LINE

Front boundaries should respond to the boundaries used within adjacent dwellings to provide a continuation of the established street character. The use of hedges, fencing and low brick or flint walls are the primary boundary treatments used in the Neighbourhood Area, except in Bryanston, where only flint is the local material used.

When rear boundaries abut the settlement edge, surrounding landscape or open green spaces, soft planted boundaries of hedgerows and trees must be used to soften the transition into the natural environment and protect views.

PRIVACY AND SPACE BETWEEN BUILDINGS

Any proposed backland or infill development must not cause an unacceptable impact on the residential amenity of adjacent residential properties.

Hedges and fences usually protect privacy at ground floor level, so any privacy issues tend to arise from upstairs windows either looking into neighbours' windows or down into their private garden space.

To avoid overlooking of habitable rooms and gardens, a minimum distance of 15 metres should be achieved between dwellings where a side elevation of one dwelling faces a rear elevation of another. Where a side elevation is windowless the separation distance can be reduced to 12 metres. In the low-density residential neighbourhoods, a minimum separation distance of 21 metres should be achieved between facing windowed rear elevations. However, the plots are generally tighter in the town centre and less separation distance might be acceptable.

Space between side elevations should allow for breaks the building line to protect views and provide adequate space for access and storage



F.125

Figure 125: New building to the left fails to respect the original row of properties on Park Road (Source: Blandford Plus NP Steering Group)

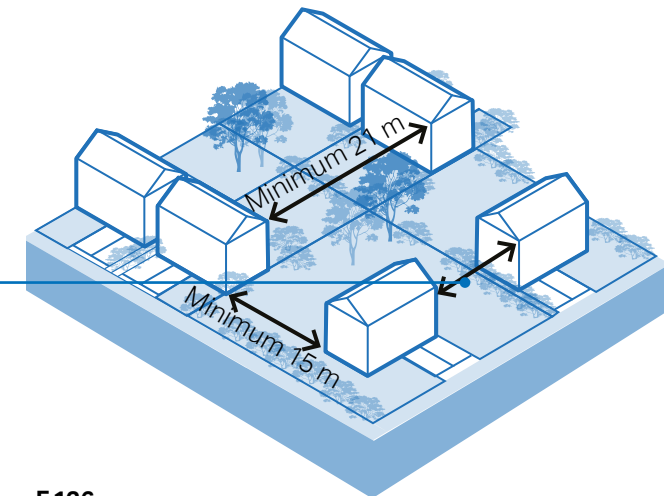

F.126

Figure 126: Diagram showing privacy and space between buildings



Figure 127: The Cedars, left, and Badger House, right, are an example of unsympathetic infill redevelopment and good restoration at the Badger crossroads (Source: Blandford Plus NP Steering Group)

Figure 128: New chalet style bungalow in the Conservation Area off Salisbury street, north of the market square which is well-built but materials and style do not match grade listed buildings in close proximity and also do not follow the medieval burgage plot layout of the town (Source: Blandford Plus NP Steering Group)

Figure 129: A positive example of infill development which respects the architecture and use of materials used in adjacent developments on Salisbury Road/Fairfield Road (Source: Blandford Plus NP Steering Group)

Figure 130: A positive example of infill development on St Leonard's Avenue/Wimborne Road (Source: Blandford Plus NP Steering Group)



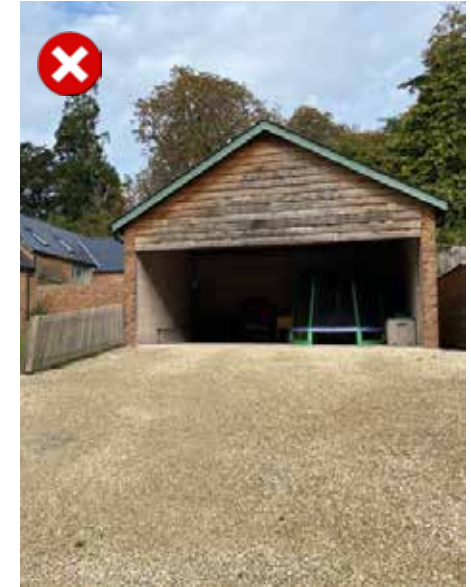

Figure 131: A good infill development, the former Half Moon public house, on Whitecliff Mill Street (Source: Blandford Plus NP Steering Group)

Figure 132: Traditional building (left) built by Bryanston School. It is in keeping with the rural farm-like setting. However the building is obscured from the front by an over scaled garage (right) in front (Source: Blandford Plus NP Steering Group)

Figure 133: A sympathetic infill development on Oakfield Street (Source: Blandford Plus NP Steering Group)

Figure 134: Ashwood Row built mid 90s showing Bryanston character feature. It is built with blue banding, sash window with stone sill and feature window arches, feature gables, red brick and traditional style railings (Source: Blandford Plus NP Steering Group)

CODE 15. ARCHITECTURE DETAILS, MATERIALS AND COLOUR PALETTE

Blandford Forum has national importance as an important Georgian country town. It has a strong historic and architectural character due to its significant historical background and the intact medieval town plan.

There are a variety of architectural styles in the Neighbourhood Area. The majority of buildings within the town centre date from the 18th and 19th century. The medieval town layout and burgage plots provide a worthy backdrop upon which the Georgian town sits adjacent to the river.

The building typologies include a very high density of historic buildings, post-medieval suburb, locally rare surviving 17th century buildings, large houses and grounds, and mid-19th century suburban villas.



F.135



F.137



F.136

Figure 135: A mix of dark red brick and cream stone as decoration for window and pillars on three storey building - a Grade I listed building - on Market Place

Figure 136: Flats on Bournemouth Road. Built with hung tiles and pale pink bricks and brown pantiles in Blandford St Mary Character Area

Figure 137: The Old Powerhouse, now the Old Powerhouse, the former electricity generating station for Portman Estate Model Farm complex in old Bryanston. A former industrial building displaying a simpler form of the red brick and slate materials associated with the Portman Estate cottages

Some of the buildings have modern extensions and alterations. New developments should encourage and support innovative and proactive approaches to design and opportunities to deliver decentralised energy systems powered by a renewable or low carbon source and associated infrastructure, including community-led initiatives.

New developments should strive for good quality design that meets climatic targets for CO2 emissions and that can be constructed sustainability, maximising opportunities for recycling.

Informed by the local vernacular, the following pages illustrate acceptable materials and detailing for future housing developments in the Neighbourhood Area. The use of traditional architectural finishes should be specified for all new development and repair work. The requirement for additional housing in the Neighbourhood Area should not trump architectural quality and character of the area.



F.138



F.139



F.140

Figure 138: Historic housing in the Conservation Area, situated to the south of Market Square. There are burgage plots to the back of the buildings with compact building plots

Figure 139: Mix use of dark brown brick and red brick on a Georgian property in Blandford Forum

Figure 140: A detached house with garage on Preetz Way. It is built with hung tile and pale red brick



Figure 141: Whiterenderedhousesfollowing the road layout on Damory Court Street

Figure 142: White painted brick and sash window used in a detached house on Damory Court Street

Figure 143: A row of terraced houses with dark brown tile on Chapel Gardens

Figure 144: Yellow-rendered terraced house along with other adjoining buildings with red brick and grey rendered facade on Dorset Street

Future developments should carefully apply this code to avoid pastiche interpretations of the existing vernacular. Detailing using contemporary methods can help avoid this.

Conversions of existing historic buildings for residential use should preserve and enhance any existing heritage features and maintain the original building's integrity. New fenestration should be positioned carefully to retain character and balance, reflecting the building's existing design while using complementary materials and finishes. These buildings can provide large single dwellings or can be split into a series of smaller dwellings.

WALL MATERIALS

There are different wall materials in the Neighbourhood Area, including red brick, decorative blue bricks in laines or patterns, pale pink bricks, render and flint.

WINDOW & DOOR MATERIALS

There are various window and door typologies used in the Neighbourhood Area. Sash windows are commonly used

throughout the Neighbourhood area, reflecting the heritage value of many of Blandford's buildings. Timber detailings should be prioritised for windows and doors on historic buildings.

ROOF MATERIALS

Dark pink/ red/ brown roof tiles and slate are common roof materials in the Neighbourhood Area. The majority of buildings have pitched roofs, with a mix of gable and hipped forms.

GROUND SURFACE MATERIALS

Generally tarmac is used for surface treatments in the Neighbourhood Area, but there are also some examples of gravel and block paving.

BOUNDARY TREATMENT MATERIALS

There is a wide variety of boundary treatments in the Neighbourhood Area such as hedges, low walls with red brick and/or flint, shrubs and wooden fencing.

Wall

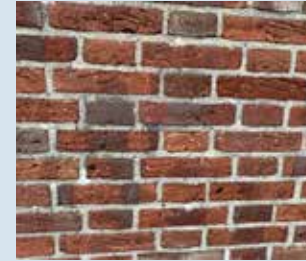

Dark red brick



Mix of flint and red brick



Yellow render



Green render



Mix of various tone of red brick



Brickwork in Flemish Bond

Fenestration



Sash window



Bay window



Sash window including stone sill and feature window arches



Casement window



Sash window



Wooden door and frame details



Grey wooden door and details



Wooden door



Black wooden door

Roof



Red roof tile



Slate



Shed dormer



Hipped dormer



Dutch gable



Chimney stack

Ground surface



Gravel



Stone paviours
(Market Place)



Concrete slabs



Grey tarmac



Herringbone paving



Brown tarmac

Boundary treatment



Shrubs



Hedges



Mix of fencing and low
wall with brown brick



Mix of fencing and
low wall



Mix of hedges and
low wall with red
brick



Well-kept front
garden

Colour palette

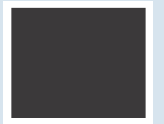

EE. Environmental and Energy Efficiency

Design codes in the following section apply to the whole Neighbourhood Area. They contain important recommendations that will help to reduce our collective impact on the planet while allowing the natural environment to flourish.

They include general guidance that apply to both new and existing development as some of the policies can be used to modify existing dwelling to become more environmentally sustainable.

Owing to the Neighbourhood Area's rich green space character, it is hoped that more of these policies are adopted in the future to help preserve and sustain this distinct character.

CODE 16. FEATURES IN DWELLINGS

The following section elaborates on energy efficient technologies that could be incorporated in buildings and at broader Neighbourhood Area design scale as principles.

Use of such principles and design tools should be encouraged in order to contribute towards a more sustainable environment.









Energy efficient or eco design combines all around energy efficient appliances and lighting with commercially available renewable energy systems, such as solar electricity and/or solar/ water heating and electric charging points.



F.145

Figure 145: Diagram showing low-carbon homes in both existing and new build conditions.

Existing homes

- 1  **Insulation**
in lofts and walls
(cavity and solid)
- 2  **Double or triple glazing with shading**
(e.g. tinted window film, blinds, curtains and trees outside)
- 3  **Low-carbon heating**
with heat pumps or connections to district heat network
- 4  **Draught proofing**
of floors, windows and doors
- 5  **Highly energy-efficient appliances**
(e.g. A++ and A+++ rating)
- 6  **Highly waste-efficient devices**
with low-flow showers and taps, insulated tanks and hot water thermostats
- 7  **Green space (e.g. gardens and trees)**
to help reduce the risks and impacts of flooding and overheating
- 8  **Flood resilience and resistance**
with removable air back covers, relocated appliances (e.g. installing washing machines upstairs), treated wooden floors

Existing and new build homes

- A  **High levels of airtightness**
- B  **Triple glazed windows and external shading**
especially on south and west faces
- C  **Low-carbon heating**
and no new homes on the gas grid by 2025 at the latest
- D  **More fresh air**
with mechanical ventilation and heat recovery, and passive cooling
- E  **Water management and cooling**
more ambitious water efficiency standards, green roofs and reflective walls
- F  **Flood resilience and resistance**
e.g. raised electrical, concrete floors and greening your garden
- G  **Construction and site planning**
timber frames, sustainable transport options (such as cycling)
- H  **Solar panels**
- I  **Electric car charging point**

CODE 17. BUILDING FABRIC

THERMAL MASS

Thermal mass describes the ability of a material to absorb, store and release heat energy. Thermal mass can be used to even out variations in internal and external conditions, absorbing heat as temperatures rise and releasing it as they fall. Thermal mass can be used to store high thermal loads by absorbing heat introduced by external conditions, such as solar radiation, or by internal sources such as appliances and lighting, to be released when conditions are cooler. This can be beneficial both during the summer and the winter.

Thermal storage in construction elements can be provided, such as a trombe wall placed in front of a south facing window or concrete floor slabs that will absorb solar radiation and then slowly re-release it into the enclosed space. Mass can be combined with suitable ventilation strategies.

INSULATION

Thermal insulation can be provided for any wall or roof on the exterior of a building to prevent heat loss. Particular attention should be paid to heat bridges around corners and openings at the design stage.

Provide acoustic insulation to prevent the transmission of sound between active (i.e. living room) and passive spaces (i.e. bedroom). Provide insulation and electrical insulation to prevent the passage of fire between spaces or components and to contain and separate electrical conductors.

AIRTIGHTNESS

Airtight constructions help reduce heat loss, improving comfort and protecting the building fabric. Airtightness is achieved by sealing a building to reduce infiltration- which is sometimes called uncontrolled ventilation. Simplicity is key for airtight design. The fewer junctions the simpler and more efficient the airtightness design will be.

An airtight layer should be formed in the floor, walls and roof. Doors, windows and roof lights to the adjacent walls or roof should be sealed. Interfaces between walls and floor and between walls and roof, including around the perimeter of any intermediate floor should be linked. Water pipes and soil pipes, ventilation ducts,

incoming water, gas, oil, electricity, data and district heating, chimneys and flues, including air supplies to wood burning stoves, connections to external services, such as entry phones, outside lights, external taps and sockets, security cameras and satellite dishes should be considered.

The opposite diagram illustrates some of these key considerations.

However, given Blandford's concentration of historic buildings and heritage assets, consideration must also be given to traditionally constructed buildings and the need to maintain or reinstate breathability to avoid potentially detrimental impacts on their fabric and internal environment. Where applicable, advice from historic buildings specialists and/or direct to Historic England's suite of guidance on energy efficiency and historic buildings should be sought.

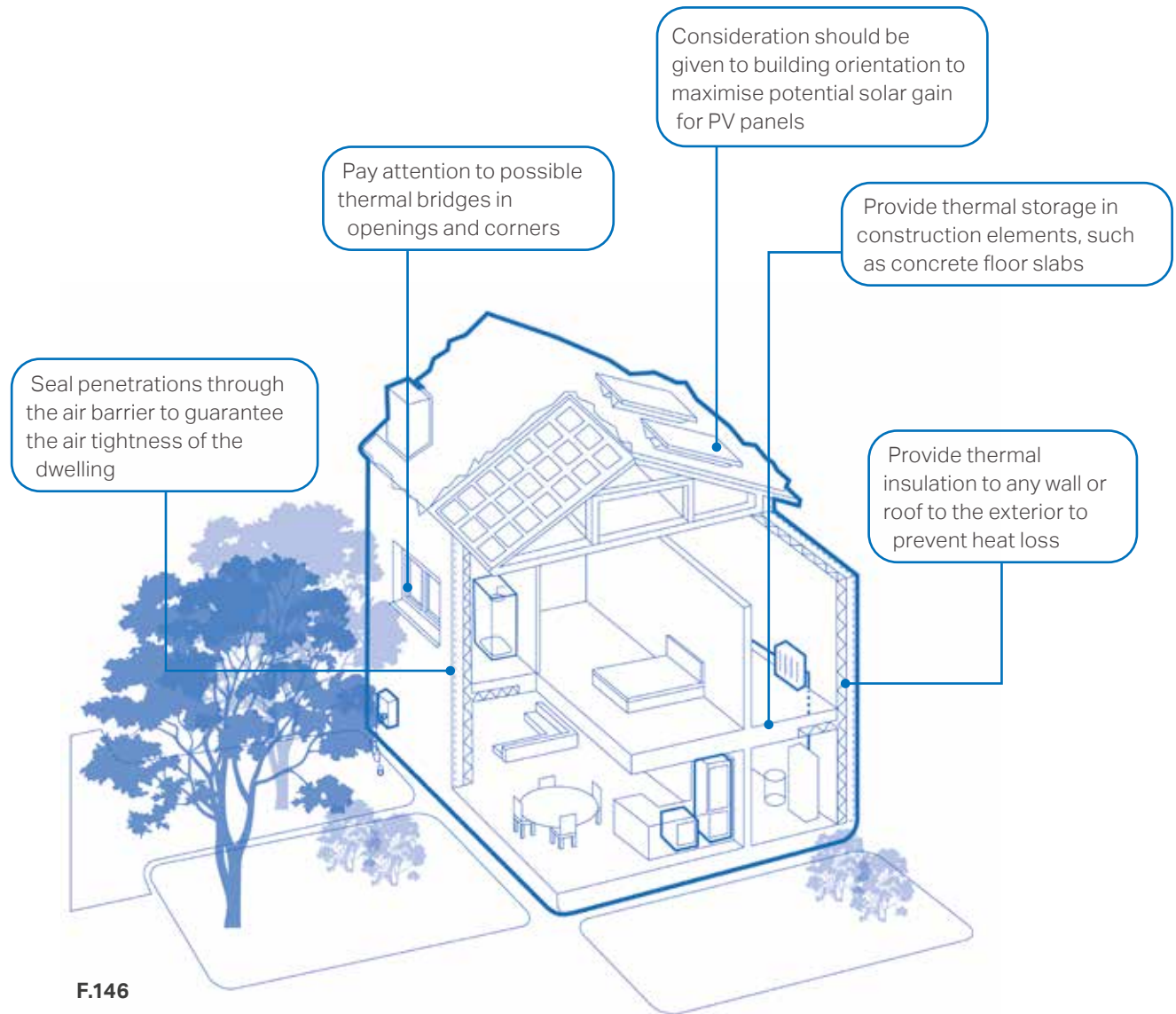

F.146

Figure 146: Diagram illustrating aspects of the building fabric to be considered

CODE 18. FLOOD MITIGATION

Part of the Neighbourhood Area is affected by medium and high flood risks (see **Figure 19**). There are various ways to mitigate flood risk such as Sustainable urban Drainage System (SuDS), rainwater harvesting, and permeable pavements, which the following pages elaborate on.

SUSTAINABLE URBAN DRAINAGE SYSTEM (SUDS)

The term SuDs covers a range of approaches to managing surface water in a more sustainable way in order to reduce flood risk and improve water quality whilst improving amenity benefits.

SuDS work by reducing the amount and rate at which surface water reaches a waterway or combined sewer system. Usually, the most sustainable option is collecting this water for reuse, for example in a water butt or rainwater harvesting system, as this has the added benefit of

reducing pressure on important water sources.

Where reuse is not possible there are two alternative approaches using SuDS:

- Infiltration, which allows water to percolate into the ground and eventually restore groundwater; and
- Attenuation and controlled release, which holds back the water and slowly releases it into the sewer network. Although the overall volume entering the sewer system is the same, the peak flow is reduced. This reduces the risk of sewers overflowing. Attenuation and controlled release options are suitable when either infiltration is not possible (for example where the water table is high or soils are clay) or where infiltration could be polluting (such as on contaminated sites).

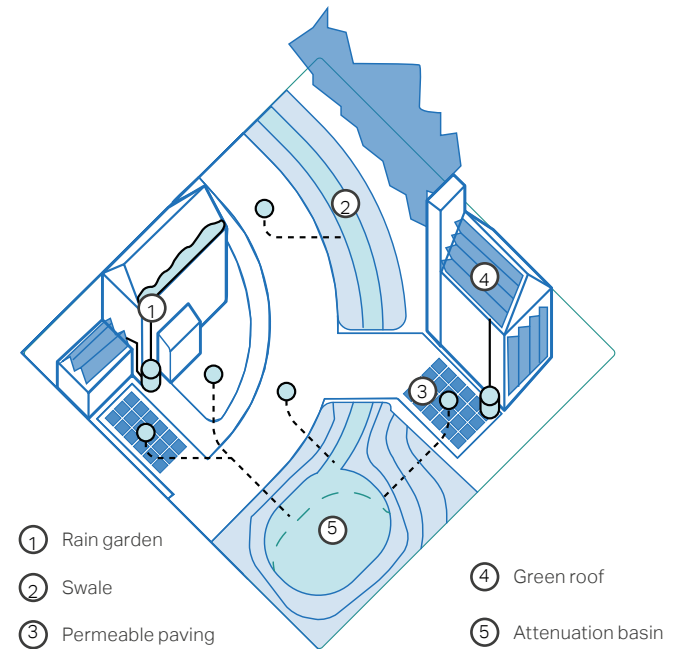

F.147

Figure 147: Diagram showing the best use of harvesting water systems rain garden, swales, permeable paving, green roofs

The most effective type or design of SuDS would depend on site-specific conditions such as underlying ground conditions, infiltration rate, slope, or presence of ground contamination. A number of overarching principles can however be applied:

- Reduce runoff rates by facilitating infiltration into the ground or by providing attenuation that stores water to help slow its flow down so that it does not overwhelm water courses or the sewer network;
- Integrate into development and improve amenity through early consideration in the development process and good design practices;
- SuDS are most valuable in areas that are not impacted by flood risk, as they can help reduce downstream flood risk by storing water upstream;
- Some of the most effective SuDS are vegetated, using natural processes to slow and clean the water whilst increasing the biodiversity value of the area;
- Best practice SuDS schemes link the water cycle to make the most efficient use of water resources by reusing surface water; and
- SuDS must be designed sensitively to augment the landscape and provide biodiversity and amenity benefits.



F.148

Figure 148: Examples of SuDS designed as a public amenity and fully integrated into the design of the public realm, Sweden

RAINWATER HARVESTING

Rainwater harvesting is a system for capturing and storing rainwater as well as enabling the reuse of in-situ grey water. Some design considerations include:

- Concealing tanks with complementary cladding;
- Use attractive materials or finishing for pipes, unsightly pipes should be avoided;
- Combine landscape or planters with water capture systems; and
- Use underground tanks.



F.149

Figure 149: Example of a rainwater harvesting tank in the shape of a bee hive



F.150

Figure 150: Example of a modular water tank

PERMEABLE PAVEMENTS

Most built-up areas, including roads and driveways, increase impervious surfaces and reduce the capacity of the ground to absorb runoff water. This in turn increases the risks of surface water flooding.

Permeable pavements offer a solution to maintain soil permeability while performing the function of conventional paving. The choice of permeable paving units must be made depending on the local context; the units may take the form of unbound gravel, clay pavers, or stone setts.

Permeable paving can be used where appropriate on footpaths, public squares, private access roads, driveways, and private areas within the individual development boundaries.

It is recommended that the majority of the unbuilt areas in the plot (i.e. gardens) are permeable by means of landscape such as grass or earth as well as permeable and

filtrating pavements. As a rule of thumb the proportion of permeable area should be between 30% to 70% of the unbuilt areas.

In addition, permeable pavement must also comply with:

- Flood and Water Management Act 2010, Schedule 3;¹
- The Building Regulations Part H – Drainage and Waste Disposal;² and
- Town and Country Planning (General Permitted Development) (England) Order 2015³.

¹ Great Britain (2010). *Flood and Water Management Act, Schedule 3*. Available at: <http://www.legislation.gov.uk/ukpga/2010/29/schedule/3>

² Great Britain (2010). *The Building Regulations Part H – Drainage and Waste Disposal*. Available at: https://assets.publishing.service.gov.uk/government/uploads/system/uploads/attachment_data/file/442889/BR_PDF_AD_H_2015.pdf

³ Great Britain (2015). *Town and Country Planning (General Permitted Development) (England) Order 2015*. Available at: http://www.legislation.gov.uk/uksi/2015/596/pdfs/ukxi_20150596_en.pdf

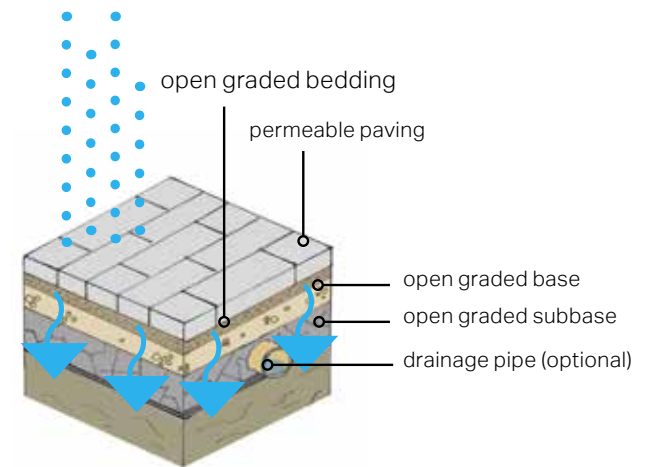
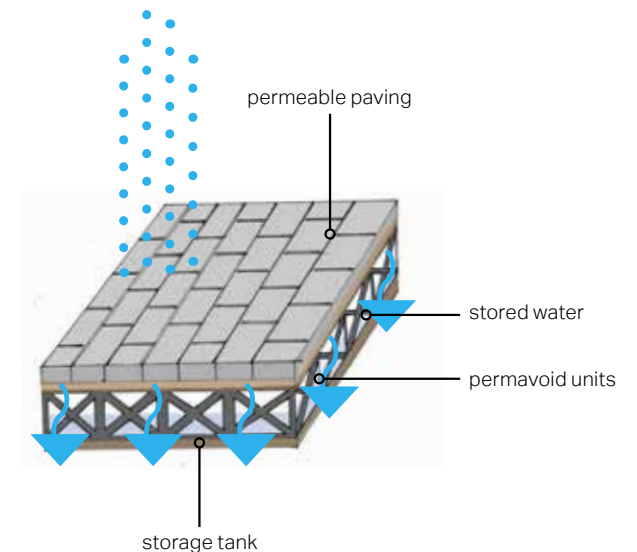

F.151

Figure 151: Diagrams illustrating the functioning of a soak away

Regulations, standards, and guidelines relevant to permeable paving and sustainable drainage are listed below:

- Sustainable Drainage Systems - non-statutory technical standards for sustainable drainage systems;⁴
- The SuDS Manual (C753);⁵
- BS 8582:2013 Code of practice for surface water management for development sites;⁶
- BS 7533-13:2009 Pavements constructed with clay, natural stone or concrete pavers;⁷ and
- Guidance on the Permeable Surfacing of Front Gardens.⁸

⁴ Great Britain. Department for Environment, Food and Rural Affairs (2015). *Sustainable drainage systems – non-statutory technical standards for sustainable drainage systems*. Available at: https://assets.publishing.service.gov.uk/government/uploads/system/uploads/attachment_data/file/415773/sustainable-drainage-technical-standards.pdf

⁵ CIRIA (2015). *The SuDS Manual (C753)*.

⁶ British Standards Institution (2013). *BS 8582:2013 Code of practice for surface water management for development sites*. Available at: <https://shop.bsigroup.com/ProductDetail/?pid=00000000030253266>

⁷ British Standards Institution (2009). *BS 7533-13:2009 Pavements constructed with clay, natural stone or concrete pavers*. Available at: <https://shop.bsigroup.com/ProductDetail/?pid=00000000030159352>

⁸ Great Britain. Ministry of Housing, Communities & Local Government (2008). *Guidance on the Permeable Surfacing of Front Gardens*. Available at: https://assets.publishing.service.gov.uk/government/uploads/system/uploads/attachment_data/file/7728/pavingfrontgardens.pdf



Figure 152: A good example of permeable paver (Source: <https://www.paverconnection.com/testimonial/hedwig-village-permeable-driveway-and-patio-upgrade/>)



Figure 153: A good example of clay paver (Source: <https://www.londonstone.co.uk/brick-pavers/paving-bricks/>)

CODE 19. WASTE STORAGE AND SERVICING

With modern requirements for waste separation and recycling, the number and size of household bins has increased. This poses a problem with the aesthetics of the property.

- Servicing arrangements should have a specific and attractive enclosure of sufficient size for all the necessary bins, this avoids the blocking of pavements with bins and makes the public realm more attractive. The storage solutions should be kept to the minimum dimensions in order to prevent the footprint being converted into an annexe at a later date;
- Create a specific enclosure of sufficient size for all the necessary bins;

- Bins should be placed as close as possible to the dwelling's boundary and the public highway, such as against wall, fence or hedge;
- Refer to the materials palette to analyse what would be a complementary material;
- Create an environmentally sustainable enclosure to contain all bins; and
- The illustrations below show some successful design solutions for accommodating bins within the plot.



F.154

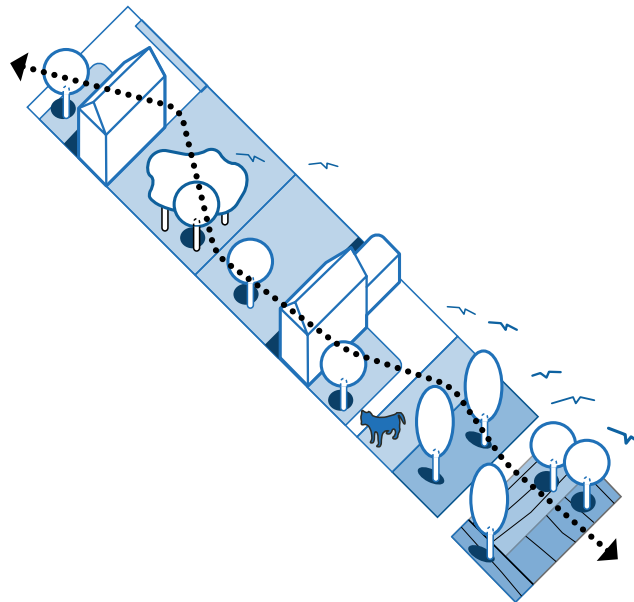

Figure 154: Examples of successful storage design solutions for accommodating bins and bicycles at the front of buildings

CODE 20. WILDLIFE FRIENDLY FEATURES

Biodiversity and woodlands should be protected and enhanced where possible.

- Roadside verges, hedges, and trees should act as natural buffers and should be protected when planning new developments;
- Abrupt edges to development with little vegetation or landscape on the edge of the settlement should be avoided and, instead, comprehensive landscape buffering should be encouraged;
- New developments and building extensions should aim to strengthen biodiversity and the natural environment;
- Ensure habitats are buffered. Widths of buffer zones should be wide enough and based on specific ecological function;



F.155

Figure 155: Diagram to highlight the importance of creating wildlife corridors

Figure 156: Examples of a bughouse decorating rear gardens or public green spaces

Figure 157: Examples of a frog habitat decorating rear gardens or public green spaces



F.156



F.157

- New development proposals should include the creation of new habitats and wildlife corridors such as planting wildflowers and bulbs on the village green spaces, meadows and verges. This could be by aligning back and front gardens or installing bird boxes or bricks in walls. Wildlife corridors should be included to enable local wildlife to travel to and from foraging areas and their dwelling area;
- Avoid low maintenance gardens which are harmful to wildlife by reducing hard landscaping; and
- The loss of any tree and garden should be discouraged. Encourage permeable pavement and gardens which is beneficial to biodiversity net gain.



Figure 158: A view toward Bryanston School Playing Field

4.2 How to apply design codes to character areas

The character area codes are designed to provide specific guidance to areas within the Blandford Plus Neighbourhood Area. These areas were set out in the character analysis undertaken in chapter 3. The specific guidance builds upon the general design codes outlined in the previous section and highlights guidelines that will both preserve and enhance the existing character of the area. These should be read jointly with the previous codes.

Developers seeking to build in these areas should refer to these sections when considering the development layout, placemaking and architectural features of new development.

CA1. Blandford Forum and Approaches

CA2. Blandford Town

CA3. Bryanston

CA4. Blandford Forum Residential

CA5. Industrial

CA6. Edge of the Town

CA7. Blandford St Mary Residential

CA8. Bryanston Rural Area

CA9. Countryside of Blandford St Mary

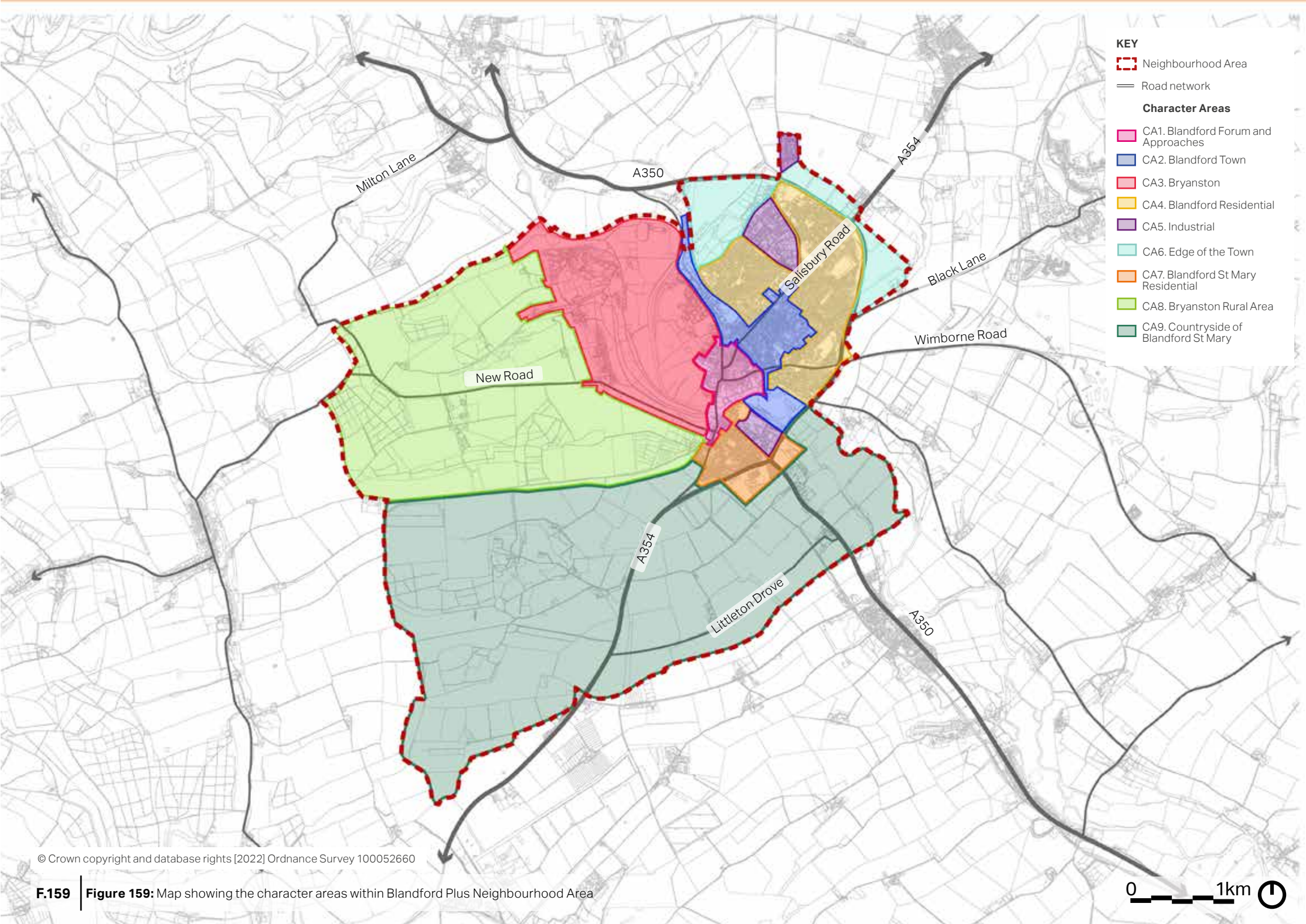

F.159 | **Figure 159:** Map showing the character areas within Blandford Plus Neighbourhood Area

CA1. Blandford Forum and Approaches

CODE 1- Buildings should front onto the streetscape following the linear settlement pattern typical of the Conservation Area, and retain historical burgage plot layouts where appropriate.

CODE 2 - New developments should be in keeping with the continuous building line and subtle changes in rooflines, and maintain a good sense of enclosure.

CODE 4 - New developments should create safe pedestrian and cycling connections that link with key areas of the town, such as Market Place, to encourage active travel.

CODE 5 - Protect and enhance key landmarks and buildings within the Conservation Area (e.g. Corn Exchange and St Peter and St Paul's Church on Market Place) that serve as important wayfinding aids.

CODE 14 - Any infill developments should be sympathetic to the historical character of the Conservation Area, in terms of the existing style, massing and layout of buildings.

CODE 15 - New developments should use materials that are reflective of the historical vernacular of the conservation area. These include brick and stone for building facades and clay tiles and slates for roofs.



F.160

CODE 5



F.161

Figure 160: Buildings fronting directly onto the street forming a linear pattern, where changes to the rooflines are subtle, Dorset Street.

Figure 161: Views towards landmark buildings, like the Corn Exchange, should be protected and not obstructed by new development.

CA2. Blandford Town

CODE 1 & 2- New developments should reference the existing residential layout of this part of the Conservation Area, such as its grid pattern and occasional cul-de-sacs, that contribute towards the character of this area.

CODE 2- Proposed developments should provide pavements with adequate width that serve the needs of a variety of pedestrians and to maximise safety.

CODE 7- New developments should respect existing open spaces, such as those along the riverside of River Stour, and enhance access to them by creating safe connections.

CODE 12- New development should clearly define property boundaries with materials such as low brick walls and hedges which are commonly featured across this residential part of the Conservation Area.

CODE 14- Any proposed infill developments should integrate with the existing residential character sympathetically and conform with the existing building line, scale, massing and maximum building height of 2 storeys.

CODE 15- New developments should respect the local material palette and vernacular that are traditional to this part of the Conservation Area.

CODE 18- Flood risk mitigation measures (e.g. SUDS) should be incorporated in new developments to mitigate the risks of flooding from River Stour to the west.

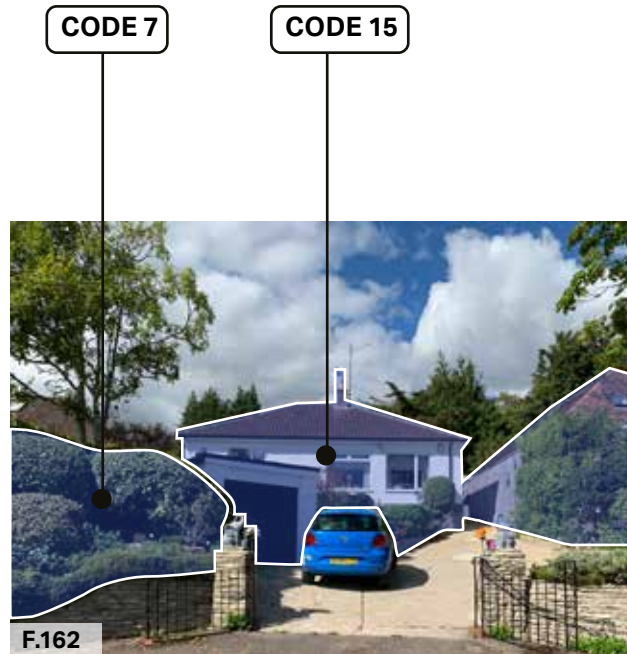

Figure 162: A bungalow with garage on St Leonard's Avenue. The railing and low wall built with yellow brick are the property boundary treatment.



Figure 163: The row of well-built detached and semi-detached houses with red brick, patterned brick and slate on Salisbury Road

CA3. Bryanston

CODE 1 & 2- New developments should respect the largely linear pattern of development in Bryanston, particularly that of The Cliff, and front onto streets to maintain enclosure along the streetscape.

CODE 3 & 4- New developments should be designed to be permeable and provide sufficiently wide pavements (min. 2m) and cycle links that connect with key amenities in Bryanston (such as Bryanston School), services in Blandford and the surrounding countryside.

CODE 6- On-plot parking is recommended to avoid cluttering streets that are already narrow in Bryanston with excessive on-street parking.

CODE 11- Building heights should not exceed 2 storeys and new developments should avoid obstructing views towards surrounding woodlands.

CODE 12- Large grass verges seen along the Cliff are recommend as boundary treatments as they contribute towards a subtle transition into the rural setting surrounding Bryanston.



Figure 164: Row of detached houses along The Cliff with deep open front gardens provide a feeling of openness (Source: Google Maps)



Figure 165: View towards the River Stour over the open playing fields of Bryanston School

CODE 4

CA4. Blandford Forum Residential

CODE 1 & 2- Residential development should follow the nucleated pattern of development typical of Blandford Forum, where houses tend to cluster around meandering residential streets, with appropriate levels of setback.

CODE 4- Encourage active travel by connecting this character area with other parts of the Neighbourhood Area and surrounding countryside through new and improved footpaths and cycle links.

CODE 6- On-plot parking is recommended to avoid on-street parking where possible.

CODE 7- New developments should enhance the existing network of playing fields, pocket parks and allotment across as part of the designated Green Infrastructure Network proposed in the Neighbourhood Plan.

CODE 11- Building heights of new developments should not exceed 2.5 storeys and should follow existing rooflines and styles (pitched or hipped).

CODE 12- Wooden fences, low brick walls and vegetation, such as hedges and shrubs, are recommended.

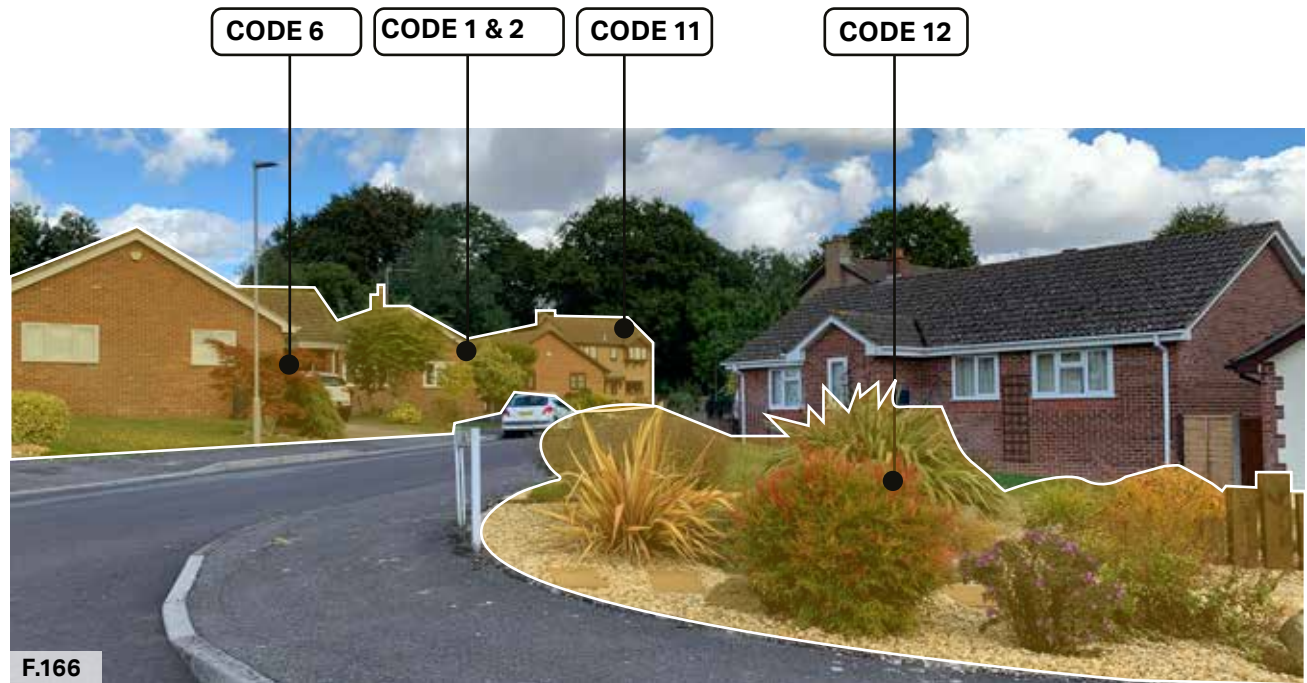

F.166

Figure 166: Bungalows with shrubs and hedges as boundary treatments on Preetz Way

Figure 167: The existing cycleway on Salisbury Road towards A350 and A354 that can be improved and connected to other part of the Neighbourhood Area

CODE 4



F.167

CA5. Industrial

CODE 1 & 2- Respect the industrial character of these areas and ensure future development complements existing uses. Access to these estates should be sensitively designed to maximise safety for pedestrians and ensuring sufficient circulation room for larger vehicles.

CODE 6- New industrial developments should provide courtyard parking, similar to existing estates in the Character Area.

CODE 7- Soften the visual impacts of predominantly hardscaped industrial estates by incorporating tree planting and vegetation in car parking areas.

CODE 11- Building heights should not exceed 2 storeys and new buildings should avoid obstructing views towards the surrounding countryside, particularly in Sunrise Business Park and Hall and Woodhouse Brewery that back onto the countryside.

CODE 12- New industrial buildings should establish appropriate landscape buffers and boundary treatments with the surrounding countryside, particularly in Sunrise Business Park and Hall and Woodhouse Brewery that back onto the countryside.



Figure 168: Sunrise Industrial Estate to the north of the Neighbourhood Area
(Source: Blandford Plus NP Steering Group)

CA6. Edge of the Town

CODE 1 & 2- New developments should follow the nucleated pattern of development seen in recent developments across the Neighbourhood Area, particularly to the south of Blandford Forum. Any new developments should not obstruct views to the countryside.

CODE 3 & 4- New developments should be designed to be permeable and provide sufficiently wide pavements (min. 2m) and cycle links that connect with surrounding neighbourhoods, the countryside and the nearby Milldown Nature Reserve.

CODE 6- On-plot parking is preferred and recommended for any proposed developments.

CODE 7- New developments should provide high quality green spaces and landscaping, any existing and mature trees should be adequately retained and incorporated.

CODE 11- Proposed developments should adhere to the average building height across the Neighbourhood Area of 2 storeys, and massing of buildings should be sympathetic to the rural setting of the Character Area.

CODE 12- New developments should establish appropriate landscape buffers and boundary treatments with the surrounding countryside.

CODE 15- New developments should adhere to the local materials palette and vernacular styles featured across the Neighbourhood Area.

CODE 16 & 17- New houses should incorporate energy efficient and eco design principles to enhance their energy performance and sustainability.

Figure 169: A detached house with deep front and back garden (Source: Blandford Plus NP Steering Group)

Figure 170: The existing building heights do not exceed 2 storeys and any future building heights should be between 1-2 storeys (Source: Blandford Plus NP Steering Group)



CA7. Blandford St Mary Residential

CODE 1- Residential development should follow the nucleated settlement pattern featured across the Neighbourhood Area, and cul-de-sacs should be avoided to increase connectivity and permeability.

CODE 4- Active travel is encouraged and new development should connect the Character Area with other parts of the Neighbourhood Area, including St Mary's Primary School, via new and improved footpaths and cycle routes.

CODE 6- On-plot parking is recommended, avoid on-street parking where possible.

CODE 10- Front and back gardens should be clearly defined to ensure they are adequately sized.

CODE 11- Building heights should not exceed 2 storeys and roof types should be in keeping with those in the Character Area, which consists of mostly pitched roofs, in order to maintain a continuous roofline.

CODE 12- Boundary treatments should use timber fences, low brick walls and hedges.

CODE 14- Any proposed infill development should complement the existing streetscape and be sympathetic to surrounding houses in terms of scale and massing.

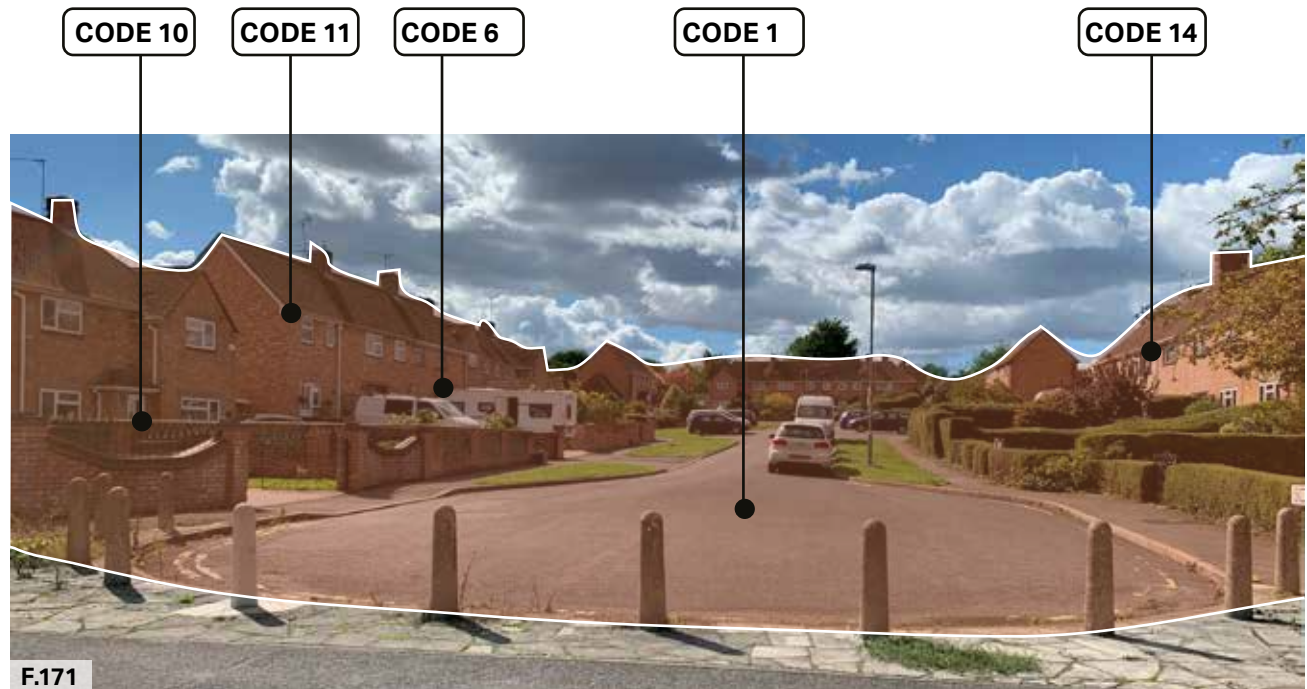

F.171

Figure 171: Use of low wall and hedges as boundary treatments on Bournemouth Road.



F.172

Figure 172: Semi-detached houses on Bournemouth Road with deep front gardens.

CODE 12

CODE 4

CA8. Bryanston Rural Area

CODE 1- Residential development should follow along the linear roads of Walnut Avenue and New Road.

CODE 4- Active travel is encouraged and new development should connect the Character Area with other parts of the Neighbourhood Area, including key amenities, via new and improved footpaths and cycle routes.

CODE 6- On-plot parking is recommended and on-street parking should be avoided to prevent cluttering the narrow country roads.

CODE 7- Any mature trees should be retained and protected, these should be integrated with any new developments.

CODE 10- Larger plots with generous front and back gardens that back onto the surrounding countryside and open fields are recommended.

CODE 11- Building heights should not exceed 2 storeys, and the massing of buildings should be sensitive to the surrounding rural landscape and should not block views towards the countryside.

CODE 12- Hedgerows and vegetation are favoured as boundary treatments.

CODE 20- Strengthen biodiversity and protect the natural environment by incorporating landscape buffers along edges of new developments.

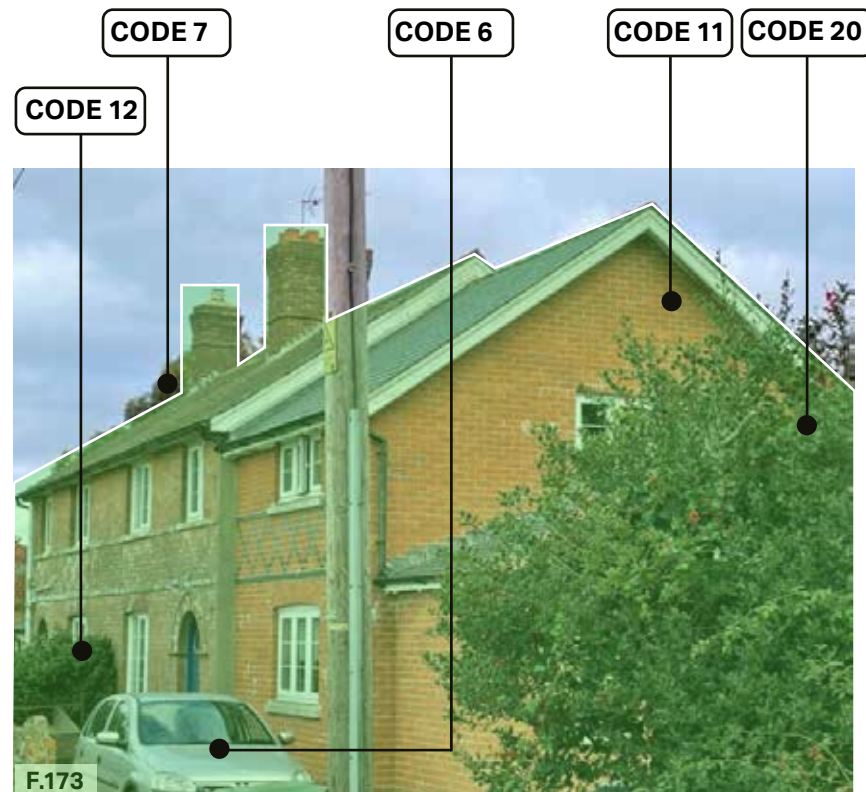

Figure 173: House just off New Road set on a large plot with large setback from the road, screened by hedges. (Source: Google Earth)

CA9. Countryside of Blandford St Mary

CODE 1- Residential development should follow along the linear roads of the A350 and Littleton Drive.

CODE 4- Active travel is encouraged and new development should connect the Character Area with other parts of the Neighbourhood Area, including key amenities, via new and improved footpaths and cycle routes.

CODE 6- On-plot parking is recommended and on-street parking should be avoided to prevent cluttering the main A350 road and narrow country roads.

CODE 7- Any mature trees should be retained and protected, these should be integrated with any new developments.

CODE 10- Larger plots with generous front and back gardens that back onto the surrounding countryside and open fields are recommended.

CODE 11- Building heights should not exceed 2 storeys, and massing of buildings should be sensitive to the surrounding rural landscape and should not block views towards the countryside.

CODE 12- Hedgerows, trees and shrubs are favoured as boundary treatments.

CODE 15- Buildings should opt for materials that reflect the local vernacular and material palette.

CODE 20- Strengthen biodiversity and protect the natural environment by incorporating landscape buffers along edges of new developments.



F.174

Figure 174: Houses along Littleton Drive set on long plots and setback from the road. (Source: Google Earth)

4.3 Checklists

Because the design guidance and codes in this document cannot cover all design eventualities, this chapter provides a number of questions based on established good practice against which the design proposal should be evaluated. The aim is to assess all proposals by objectively answering the questions below. Not all the questions will apply to every development. The relevant ones, however, should provide an assessment as to whether the design proposal has considered the local context and provided an adequate design solution.

As a first step there are a number of ideas or principles that should be present in all proposals. These are listed under 'General design guidance for new development'. Following these ideas and principles, several questions are listed for more specific topics on the following pages.



1

General design guidelines for new development:

- Integrate with existing paths, streets, circulation networks and patterns of activity;
- Reinforce or enhance the established settlement character of streets, greens, and other spaces;
- Harmonise and enhance existing settlement in terms of physical form, architecture and land use;
- Relate well to local topography and landscape features, including prominent ridge lines and long-distance views;
- Reflect, respect, and reinforce local architecture, its setting and historic distinctiveness, especially within any relevant Conservation Area.
- Retain and incorporate important existing features into the development;
- Respect surrounding buildings in terms of scale, height, form and massing;
- Adopt contextually appropriate materials and details;
- Provide adequate open space for the development in terms of both quantity and quality;
- Incorporate necessary services and drainage infrastructure without causing unacceptable harm to retained features;
- Ensure all components e.g. buildings, landscapes, access routes, parking and open space are well related to each other;
- Positively integrate energy efficient technologies;
- Make sufficient provision for sustainable waste management (including facilities for kerbside collection, waste separation, and minimisation where appropriate) without adverse impact on the street scene, the local landscape or the amenities of neighbours;
- Ensure that places are designed with management, maintenance and the upkeep of utilities in mind; and
- Seek to implement passive environmental design principles by, firstly, considering how the site layout can optimise beneficial solar gain and reduce energy demands (e.g. insulation), before specification of energy efficient building services and finally incorporate renewable energy sources.

2

Street grid and layout:

- Does it favour accessibility and connectivity? If not, why?
- Do the new points of access and street layout have regard for all users of the development; in particular pedestrians, cyclists and those with disabilities?
- What are the essential characteristics of the existing street pattern; are these reflected in the proposal?
- Is the layout of the proposal sympathetic to the character area in which it is located?
- How will the new design or extension integrate with the existing street arrangement?
- Are the new points of access appropriate in terms of patterns of movement?
- Do the points of access conform to the statutory technical requirements?

3

Local green spaces, views and character:

- What are the particular characteristics of this area which have been taken into account in the design; i.e. what are the landscape qualities of the area?
- How does the proposal affect the trees on or adjacent to the site?
- Can trees be used to provide natural shading from unwanted solar gain? i.e. deciduous trees can limit solar gains in summer, while maximising them in winter.
- Has the proposal been considered within its wider physical context?
- Has the impact on the landscape quality of the area been taken into account?
- In rural locations, has the impact of the development on the tranquillity of the area been fully considered?
- How does the proposal impact on existing views which are important to the area and how are these views incorporated in the design?
- Can any new views be created?
- Is there adequate amenity space for the development?
- Does the new development respect and enhance existing amenity space?

3 (continued)

Local green spaces, views and character:

- Have opportunities for enhancing existing amenity spaces been explored?
- Will any communal amenity space be created? If so, how this will be used by the new owners and how will it be managed?
- Is there opportunity to increase the local area biodiversity?
- Can green space be used for natural flood prevention e.g. permeable landscaping, swales etc.?
- Can water bodies be used to provide evaporative cooling?
- Is there space to consider a ground source heat pump array, either horizontal ground loop or borehole (if excavation is required)?

4

Gateway and access features:

- What is the arrival point, how is it designed?
- Does the proposal maintain or enhance the existing gaps between settlements?
- Does the proposal affect or change the setting of a listed building or listed landscape?
- Is the landscaping to be hard or soft?

5

Buildings layout and grouping:

- What are the typical groupings of buildings?
- How have the existing groupings been reflected in the proposal?
- Are the proposed groups of buildings reflective of the associated character area?
- Are proposed groups of buildings offering variety and texture to the townscape?
- What effect would the proposal have on the streetscape?
- Does the proposal maintain the character of dwelling clusters stemming from the main road?
- Does the proposal overlook any adjacent properties or gardens? How is this mitigated?

5 (continued)

Buildings layout and grouping:

- Subject to topography and the clustering of existing buildings, are new buildings oriented to incorporate passive solar design principles?
- If any of the buildings were to be heated by an individual air source heat pump (ASHP), is there space to site it within the property boundary without infringing on noise and visual requirements?
- Can buildings with complementary energy profiles be clustered together such that a communal low carbon energy source could be used to supply multiple buildings that might require energy at different times of day or night to reduce peak loads? And/or can waste heat from one building be extracted to provide cooling to that building as well as heat to another building?

6

Building line and boundary treatment:

- What are the characteristics of the building line?
- How has the building line been respected in the proposals?
- Has the appropriateness of the boundary treatments been considered in the context of the site?

7

Building heights and rooflines:

- What are the characteristics of the roofline?
- Have the proposals paid careful attention to height, form, massing and scale?
- If a higher than average building(s) is proposed, what would be the reason for making the development higher?
- Will the roof structure be capable of supporting a photovoltaic or solar thermal array either now, or in the future?
- Will the inclusion of roof mounted renewable technologies be an issue from a visual or planning perspective? If so, can they be screened from view, being careful not to cause over shading?

8

Household extensions:

- Does the proposed design respect the character of the area and the immediate neighbourhood, and does it have an adverse impact on neighbouring properties in relation to privacy, overbearing or overshadowing impact?
- Is the roof form of the extension appropriate to the original dwelling (considering angle of pitch)?
- Do the proposed materials match those of the existing dwelling?
- In case of side extensions, does it retain important gaps within the street scene and avoid a 'terracing effect'?
- Are there any proposed dormer roof extensions set within the roof slope?
- Does the proposed extension respond to the existing pattern of window and door openings?
- Is the side extension set back from the front of the house?
- Does the extension offer the opportunity to retrofit energy efficiency measures to the existing building?
- Can any materials be re-used in situ to reduce waste and embodied carbon?

9

Building materials and surface treatment:

- What are the characteristics of the roofline?
- Have the proposals paid careful attention to height, form, massing and scale?
- If a higher than average building(s) is proposed, what would be the reason for making the development higher?
- Will the roof structure be capable of supporting a photovoltaic or solar thermal array either now, or in the future?
- Will the inclusion of roof mounted renewable technologies be an issue from a visual or planning perspective? If so, can they be screened from view, being careful not to cause over shading?

9 (continued)

Building materials and surface treatment:

- Are recycled materials, or those with high recycled content proposed?
- Has the embodied carbon of the materials been considered and are there options which can reduce the embodied carbon of the design? For example, wood structures and concrete alternatives.
- Can the proposed materials be locally and/or responsibly sourced? E.g. FSC timber, or certified under BES 6001, ISO 14001 Environmental Management Systems?

10

Car parking:

- What parking solutions have been considered?
- Are the car spaces located and arranged in a way that is not dominant or detrimental to the sense of place?
- Has planting been considered to soften the presence of cars?
- Does the proposed car parking compromise the amenity of adjoining properties?
- Have the needs of wheelchair users been considered?
- Can electric vehicle charging points be provided?
- Can secure cycle storage be provided at an individual building level or through a central/ communal facility where appropriate?
- If covered car ports or cycle storage is included, can it incorporate roof mounted photovoltaic panels or a biodiverse roof in its design?

11

Architectural details and design:

- If the proposal is within a conservation area, how are the characteristics reflected in the design?
- Does the proposal harmonise with the adjacent properties and associated character area? This means that it follows the height massing and general proportions of adjacent buildings and how it takes cues from materials and other physical characteristics.
- Does the proposal maintain or enhance the existing landscape features?
- Has the local architectural character and precedent been demonstrated in the proposals?
- If the proposal is a contemporary design, are the details and materials of a sufficiently high enough quality and does it relate specifically to the architectural characteristics and scale of the site?
- Is it possible to incorporate passive environmental design features such as larger roof overhangs, deeper window reveals and/or external louvres/shutters to provide shading in hotter months?
- Can the building designs utilise thermal mass to minimise heat transfer and provide free cooling?
- Can any external structures such as balconies be fixed to the outside of the building, as opposed to cantilevering through the building fabric to reduce thermal bridge?



Delivery

05

5. Delivery

5.1 How to use this guide

The Design Guidance and codes will be a valuable tool in securing context-driven, high quality development within Blandford Plus Neighbourhood Area. They will be used in different ways by different actors in the planning and development process.

What follows is a list of actors and how they will use the design guidelines:

Actors	How They Will Use the Design Guidelines
Applicants, developers, and landowners	As a guide to community and Local Planning Authority expectations on design, allowing a degree of certainty – they will be expected to follow the Guidelines as planning consent is sought.
Local Planning Authority	As a reference point, embedded in policy, against which to assess planning applications. The Design Guidance and Codes should be discussed with applicants during any pre-application discussions.
Town and Parish Councils	As a guide when commenting on planning applications, ensuring that the Design Guidance and Codes are complied with.
Community organisations	As a tool to promote community-backed development and to inform comments on planning applications.
Statutory consultees	As a reference point when commenting on planning applications.

About AECOM

AECOM is the world's trusted infrastructure consulting firm, delivering professional services throughout the project lifecycle — from planning, design and engineering to program and construction management. On projects spanning transportation, buildings, water, new energy and the environment, our public- and private-sector clients trust us to solve their most complex challenges. Our teams are driven by a common purpose to deliver a better world through our unrivaled technical expertise and innovation, a culture of equity, diversity and inclusion, and a commitment to environmental, social and governance priorities. AECOM is a *Fortune 500* firm and its Professional Services business had revenue of \$13.2 billion in fiscal year 2020. See how we are delivering sustainable legacies for generations to come at [aecom.com](https://www.aecom.com) and [@AECOM](https://twitter.com/AECOM).